

Airwell

Just feel well

2018/2019

Air conditioning



Airwell

AIR CONDITIONING & HEATING

Airwell makes life easier
with dedicated services

Professionnals



INTERNET WEBSITE

Order easier online

■ www.airwell-pro.com



TECHNICAL DOCUMENTATION

Find here all the documentation you need

■ <http://lh.airwell-res.com/>



PROJECTS SERVICE

■ **Presales:** Daniel Perelle

tel ■ **+33 (0)1 76 21 82 82**



TRAININGS



■ www.airwell-academy.fr

e-mail ■ airwell-academy@airwell-res.com



AFTER-SALES SERVICE

tel ■ **+33 (0)1 76 21 82 95**

From Monday to Friday, from 8 am to 12:30 pm
and from 2 to 5pm

■ **Parts orders:** sales@adhoc-pro.com

■ **Technical support:** technical-spfr@airwell-res.com

Consumers



INTERNET WEBSITE

■ www.airwell-res.com



SELECTION ASSISTANT

■ **3D designer:**

Simulate in 3D your air conditioning from home

■ **White paper**

The expertise of a french brand



An international sales network

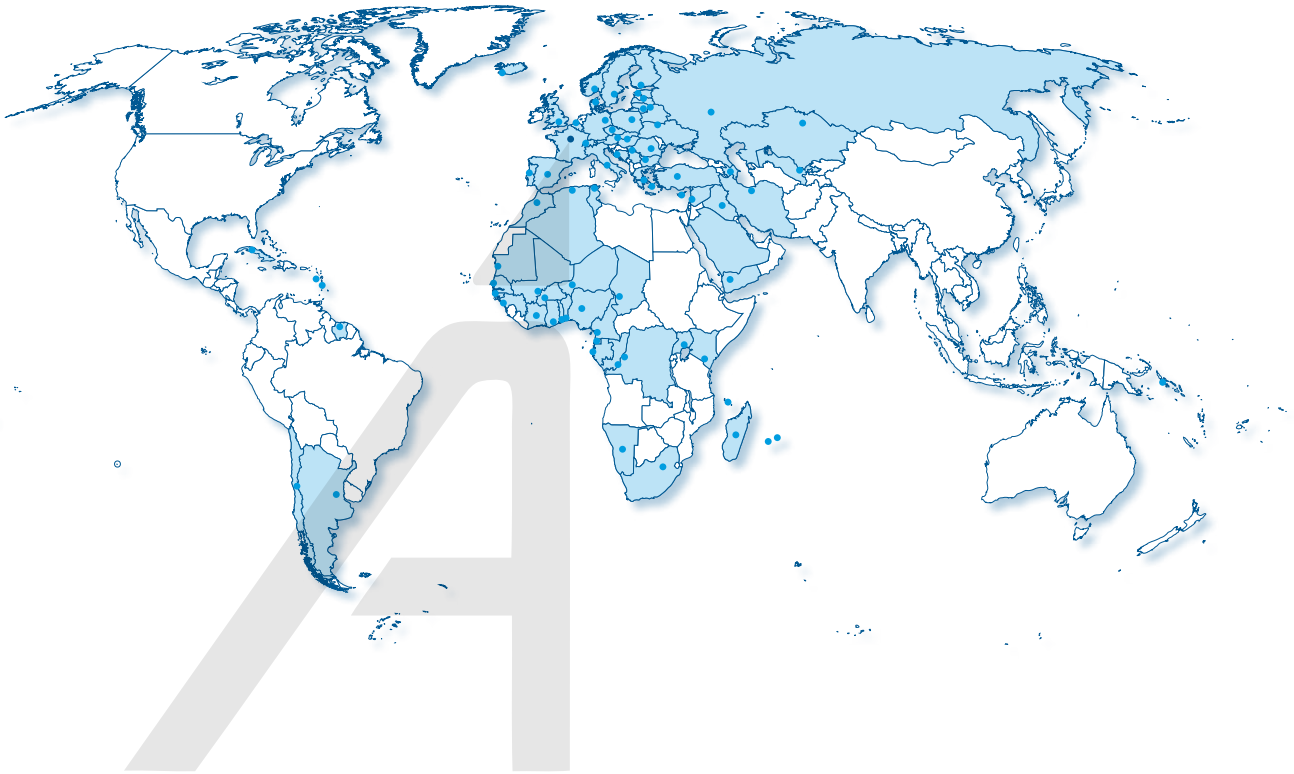

HEADQUARTERS

3, avenue du Centre - Les Quadrants - Bâtiment A
78280 Guyancourt - FRANCE

GENERAL CONTACT

tel ■ **+33 (0)1 76 21 82 00**
e-mail ■ **contact@airwell-res.com**

OUR PARTNERS



OUR CERTIFICATIONS



Table of contents

	Page
HISTORY	6
SERVICES DIVISION	8
HIGH WALL RANGE	14
HRD	High wall monosplit 16
HDM NEW	High wall mono & multisplit 18
HKD NEW	High wall mono & multisplit 20
DUCTED RANGE	22
DLF	Ducted: Horizontal and vertical installation 24
DLSE+VAV	Ducted with zone control 28
DID	Residential ducted unit 36
CASSETTE RANGE	40
CCD	Cassette mono & multisplit 42
FLOOR CEILING RANGE	46
XBD UPGRADE	Console dual flow mono & multisplit 48
FCD	Floor ceiling monosplit 50
Redundancy function NEW	52
FWDB UPGRADE	Floor ceiling monosplit for low temperature rooms 54
TWIN & MULTISPLIT RANGES	56
TWIN	Twin system 58
YCZ	Residential multisplit 60
YDZA NEW	Residential multisplit 68
MONOBLOC & FLOOR STANDING RANGES	72
MAF UPGRADE	On/off portable 74
WFD	Window 75
SDM NEW	FLOOR STANDING 76

	Page
WATER RANGE	78
CAO Water console	80
GCAO UPGRADE Water source	82
LIGHT COMMERCIAL RANGE	84
X AC Vertical air cabinet	86
X WC Vertical water cabinet	90
VRF RANGE	92
Outdoor units:	92
Mini FlowLogic II UPGRADE Front Discharge 5-6-10 HP	98
FlowLogic III Top discharge 10-14-16-18-20-24 HP	100
FlowLogic II HR NEW Top discharge 10-14-16-18-20-24 HP	110
Water FlowLogic NEW Water condensing VRF	118
Indoor units:	94
HBV High wall	120
CBV UPGRADE Cassette 600x600	122
CCV Cassette 900x900	122
FAV Floor ceiling	123
DAV Ducted low static pressure	124
DBV Ducted medium static pressure	125
DCV Ducted high static pressure	126
EAV Console	127
AHU Connection kit	128
Central control solutions	130
ACCESSORIES	134
Installation accessories	134
Control systems	136
TOOL BOX	140
ICON GUIDE	144



HISTORY



Your french expert for more than 70 years



1947 Start of the Airwell history



1950 Mass production of the first window unit

1970 Development of « Split » units

1982 Airwell, first maker in Europe to produce high wall units

2013 Launch of Zero Default objective

2014 Inauguration of training centers



2015 Start of the ENR project

2017 70 years and in the era of 3.0, Airwell is BIM ready



2018 Inauguration of presentation office in Cuba



Airwell

your expert...

TRADE

Airwell makes every effort to make life easier for its customers.

From the selection of the solution to the maintenance, through training, Airwell accompanies you in all stages of your air conditioning and heating project.



CERTIFICATIONS

Airwell is recognized for its reliability, certified **ISO 9001-2015**, at the level of marketing, after-sales service and training.



ISO 9001 - 2015 is a standard that establishes the requirements for a quality management system. It guarantees high efficiency and overall satisfaction of our customers.

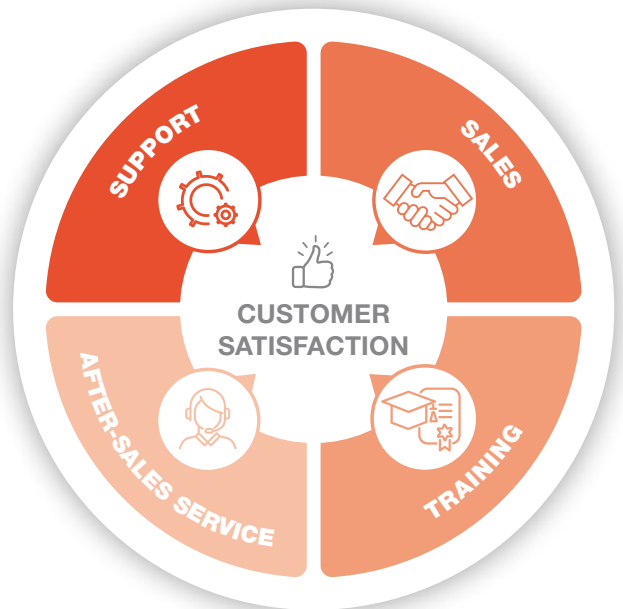

PRE-SALES

Airwell is at your disposal to assist you in the realization of your projects (residential, hotels, businesses, industrial...).

Upstream, the Pre-Sales department studies your projects, recommending the best technical solutions.

With the help of the selection software, the Pre-Sales team assists you in the design of residential and light commercial air conditioning systems.



F-GAS

FGAS

CERTIFICATION

The F-Gas regulation (EU 517/2014) came into effect on the 1st of January 2015.

Refrigerants are man-made gases that can stay in the atmosphere for centuries and contribute to the overall greenhouse effect. There are three types: hydrofluorocarbons (HFCs), perfluorocarbons (PFCs) and sulfur hexafluoride (SF6).

The F-Gas regulation, initiated by the European Commission, aims to reduce the greenhouse effect in the EU from 80 to 95% (compared to 1990 levels) in the field of air conditioning.

EQUIPMENT DISTRIBUTOR

Keeping a register including nature and the type of equipment sold

The purchaser is a distributor or operator

- ✓ Name
- ✓ SIRET or SIREN
- ✓ Certificate number of capacity issued equivalent in U.E.

The purchaser is neither distributor nor operator

- ✓ Name
- ✓ SIRET (if applicable)
- ✓ Name of the operator with from which he has contracted to assembly and commissioning equipment (SIRET No. of this one + Certificate number capacity or certificate equivalent issued in U.E.)

- ✓ Copy of the contract retained by the equipment distributor during at least 5 years (since the date acquisition of equipment).



AIRWELL ACADEMY

PRODUCT TRAINING

JOB TRAINING

SKILLS TRAINING

For more details on trainings:
www.airwell-academy.fr

Airwell

your expert...

CUSTOMERS

The French expert has an international network of partners (distributors, installers,...).

Together, you build a lasting relationship: pre-sales advice, product availability, technical sales support...

Partnership is an integral part of Airwell's DNA.

TECHNICAL SUPPORT

LOCAL AND REMOTE TECHNICAL SUPPORT

- Specialized technicians
- Direct contact by phone and on site if necessary for VIP customers
- Training on all products
- Commissioning by a Technical Station Approved by Airwell (TSA)

CALL CENTER

- Quick and effective answers delivered by our experts.
- High availability.
- A multilingual center.
- Professionals trained continuously.
- A customer and service approach first!
- Listening and assistance until the complete customer satisfaction.



+33 (0)1 76 21 82 95

DEDICATED TOOLS

INTERNET WEBSITE

Online order:

Airwell offers its referenced customers to order their products online via the WEBSITE www.airwell-pro.com

Documentation Library:

<http://lh.airwell-res.com>



BIM

Airwell is BIM Ready!

In partnership with **Stabiplan**, Airwell announces its launch in **BIM** (Building Information Modeling) and offers its tertiary and commercial air conditioning (VRF) range in BIM format broadcast on the **MEPcontent** library.

This allows REVIT® users to integrate Airwell content for all their building projects, made in the 3D digital world.

Airwell Academy offers dedicated BIM training, including an introduction to the features of REVIT®, as well as drawings of heating / cooling networks.



PARTS

FOR PRODUCTS UNDER AIWELL SUPPORT

 sales@adhoc-pro.com

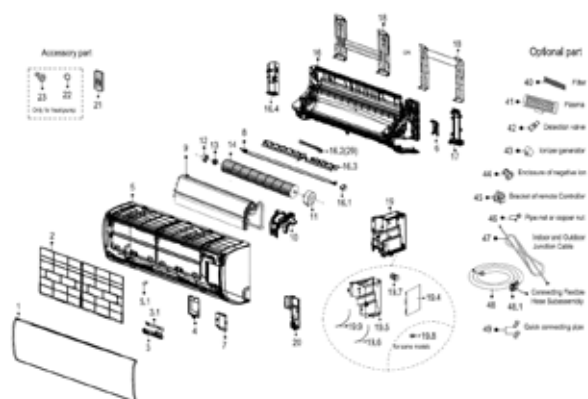

Airwell

your expert...

PRODUCTS

With a failure rate of less than 0.04%, Airwell is committed to providing reliable products.

Thanks to a wide range of products, Airwell brings you particularly flexible, efficient and competitive answers, adapted to the specific characteristics of your markets.

RANGE



INDIVIDUAL RESIDENTIAL



COLLECTIVE RESIDENTIAL



SHOPS



PUBLIC BUILDING



INDUSTRY

CERTIFICATIONS

Airwell participates in the Eurovent certification program.

Eurovent Certification certifies the performance of its air conditioning products (splits and multisplits with at least 2 indoor units), in accordance with European and international standards. This common platform for all manufacturers improves the integrity and accuracy of the industry's performance.



See Airwell products certified Eurovent on the site:

www.eurovent-certification.com



The performance of Airwell products meets EN-14825 (seasonal energy standard). Airwell's production sites are ISO 9001 and ISO 14001 certified and by most recognized certification bodies.

UNIQUE SOLUTIONS

DUCTED DLSE + VAV

- Zone Control: The ideal temperature in every room.
- Energy saving.
- The DC motor combined with the horizontal fan offers high efficiency.
- Advanced technology by controlling the compressor inverter.

More details on p. 28



DUCTED DLF

- Designed for vertical and horizontal installation.
- Compact: height 200 mm, saving space.
- Super silent.
- Invisible solution.

More details on p. 24

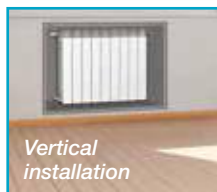
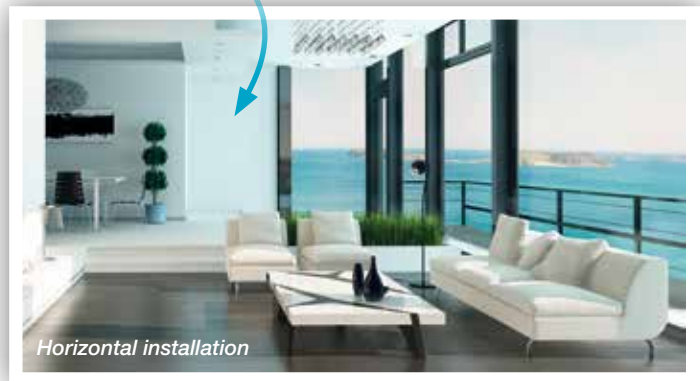

AVANT



APRÈS



WATER SOLUTIONS: CAO ET GCAO

- Ideal solution for buildings subject to local or aesthetic restrictions.
- Simple and easy installation.

More details on p. 78

ENVIRONMENTAL APPROACH

Airwell is part of an eco-environmental approach, which includes the analysis of the life cycle of its products with the development of a Product Environmental Profile (PEP).

Airwell offers a range of R32 refrigerant products with low environmental impact.

This fluid offers better performance for less pollution (low Global Warming Potential).

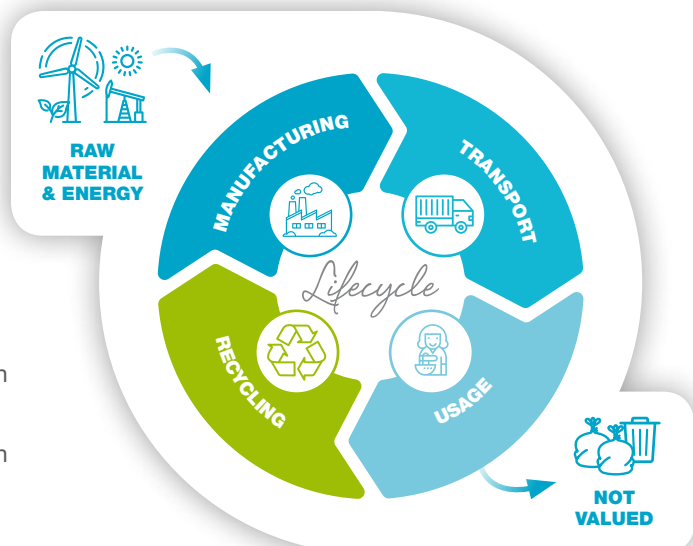

High wall range

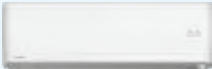

MODEL NAME	Fluid type	Page	kBTU/h kW	9 2.5	12 3.5	18 5	24 7
 HIGH WALL MONOSPLIT Designed for extreme climates	HRD	R32	16	●	●		

NEW



HIGH WALL MONOSPLIT & MULTISPLIT
Operates with refrigerant with low environmental impact

HDM	R32	18	●	●	●	●
-----	-----	----	---	---	---	---

UPGRADE



HIGH WALL MONOSPLIT & MULTISPLIT
Best seller

HKD	R410A	20	●	●	●	●
-----	-------	----	---	---	---	---

- **Optimum comfort** all year long
- **Purified air**
- **Energy savings**

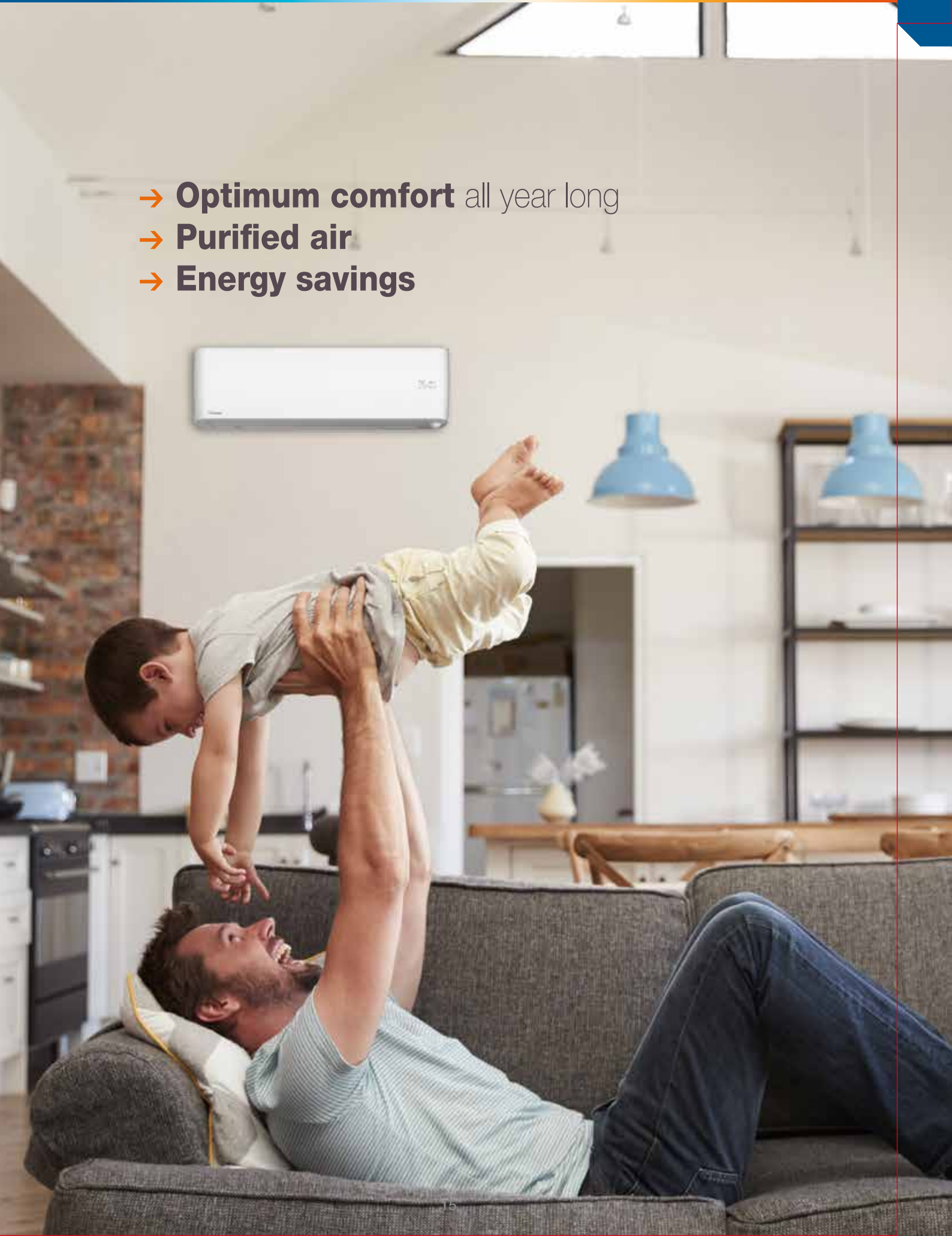



+ PRODUCTS

- Designed for extreme climates.
- R32 refrigerant with low environmental impact.
- Ultra-quiet heat pump.
- Sleek design.
- Connected solution (WiFi).



RC10 included

FEATURES

TECHNOLOGY:



DC INVERTER



R32 FLUID



ELECTRONIC EXPANSION VALVE



4D AIRFLOW

AIR QUALITY / CLEAN:



NANO PHOTOCATALYTIC FILTER



AUTO CLEAN/DRY

USER FUNCTIONS:



SLEEP MODE



QUIET MODE



REFRIGERANT LEAKAGE DETECT



PROGRAMMABLE TIMER



AUTO RESTART (MEMORY)



REMOTE CONTROL LOCK



WiFi

INSTALLER FUNCTIONS:



DIGITAL DISPLAY



SELF DIAGNOSTIC



LEFT/RIGHT DRAIN CONNECTION



SERVICE MONITOR TOOL

- High performance: operating at -30°C in heating mode.
- "Follow me": optimized airflow via a presence detector.
- High efficiency (SCOP higher than 5 and SEER higher than 8): energy savings.
- Reduced energy consumption using the hot mode alone.
- High wall with a digital display (mode, temperature...).
- Double motorized shutters for maximum thermal comfort (4 air streams).



"FOLLOW ME" FUNCTION



Wind flow away from people



Wind flow follow people



Strong wind when more people in room



Gentle wind flow when less people in room

OPTIONS

Accessory	Part number	Photo	Function
Test tool for high wall	7ACEL1710		Easy viewing of system parameters, failure records and parameter adjustments.
Central controller RCW16	7ACEL1707		Controls up to 64 indoor units with individual setting failure codes indication, ON-OFF dry contact, last operation memory, Modbus.
Air Net WiFi Module	7ACEL1719		Control air conditioners with your mobile phone, tablet or computer with wireless router and internet.



HRD TECHNICAL DATA

Indoor units		AWSI-HRD009-N91	AWSI-HRD012-N91
Outdoor units		AWAU-YRD009-H91	AWAU-YRD012-H91
Phase		Single phase	Single phase
COOLING			
Rated power (min./max.)	kW	2.65 (1.0-4.7)	3.54 (1.3-4.8)
Pdesignc	kW	2.65	3.54
Rated power input	kW	0.489	0.802
SEER/Energy label		9.3/A+++	8.5/A+++
Operating limits	°C	-15°/50° Dry bulb	
HEATING			
Rated power (min./max.)	kW	4.1 (0.9-5.2)	4.3 (1.0-6.3)
Pdesignh (average climate)	kW	2.3	2.5
Pdesignh (warmer climate)	kW	3	3.1
Pdesignh (colder climate)	kW	3.6	3.8
Rated power input	kW	0.870	1.020
SCOP/Energy Label (average climate)		5.1/A+++	5.1/A+++
SCOP/Energy Label (warmer climate)		6.1/A+++	6.1/A+++
SCOP/Energy Label (colder climate)		4.0/A+	3.4/A
Operating limits	°C	-30°/30° Dry bulb	
Power @ -10°C	kW	3.40	3.40
Power @ -15°C	kW	3.10	3.10
INDOOR UNIT			
Sound pressure level to 1 m (VL/LS/MS/HS)	dB (A)	20/23/28/32	20/24/29/33
Sound power level	dB (A)	59	59
Airflow (VL/LS/MS/HS)	m³/h	270/360/450/540/640	270/360/450/540/640
Dehumidification	l/h	1.0	1.2
Outline dimensions (WxHxD)	mm	895x298x248	895x298x248
Package dimensions (WxHxD)	mm	975x325x370	975x325x370
Net weight/Gross weight	kg	13/16	13/16
Part number		7SP023060	7SP023061
OUTDOOR UNIT			
Sound pressure level to 1 m	dB (A)	51	51
Sound power level	dB (A)	57	57
Airflow	m³/h	1980	1980
Compressor type		Rotary DC Inverter	Rotary DC Inverter
Outline dimensions (WxHxD)	mm	800x554x333	800x554x333
Package dimensions (WxHxD)	mm	900x615x390	900x615x390
Net weight/Gross weight	kg	37.8/40.5	37.8/40.5
Part number		7SP062915	7SP062916
POWER SUPPLY			
Phase/Tension/Frequency		1P/230V/50Hz	1P/230V/50Hz
Power supply side		Outdoor	Outdoor
Power cable section	mm²	3x1.5	3x1.5
Fuse rating am (D curve)	A	10	10
Electrical connections	mm²	5x1.5	5x1.5
PIPE LINE			
Suction pipe diameter	inches	3/8"	3/8"
Liquid pipe diameter	inches	1/4"	1/4"
Max. length	m	25	25
Max. height	m	10	10
Refrigerant / GWP		R32/675	R32/675
Charge (5 m)	kg	0.87	0.87
Additional charge	g/m	15	15

COMBINATIONS

Indoor unit	Compatible with outdoor unit
High wall	Monosplit
HRD	YRD
	

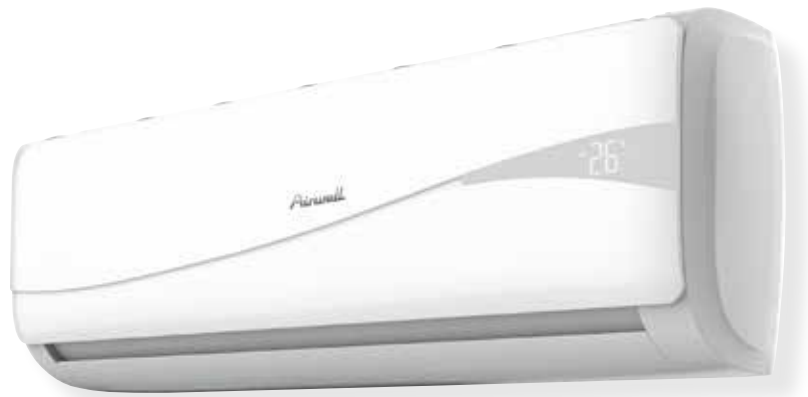

+ PRODUCTS

- Quiet heat pump.
- Monosplit & multisplit application.
- Environmental friendly refrigerant.



RC09

FEATURES

TECHNOLOGY:



FLEXY MATCH



DC INVERTER



R32 FLUID



4D AIRFLOW



MULTIFLOW 360°

AIR QUALITY / CLEAN:



AIR FILTER

USER FUNCTIONS:



SLEEP MODE



SUPER QUIET



AUTO RESTART (MEMORY)



REMOTE CONTROL LOCK

INSTALLER FUNCTIONS:



DIGITAL DISPLAY



SELF DIAGNOSTIC



LEFT/RIGHT DRAIN CONNEXION



OUTDOOR UNIT NIGHT MODE DRY CONTACT

- Economical solution: A++ class.
- High efficiency: SEER higher than 6.
- High wall with digital screen (mode, temperature...).
- Modern and elegant design.

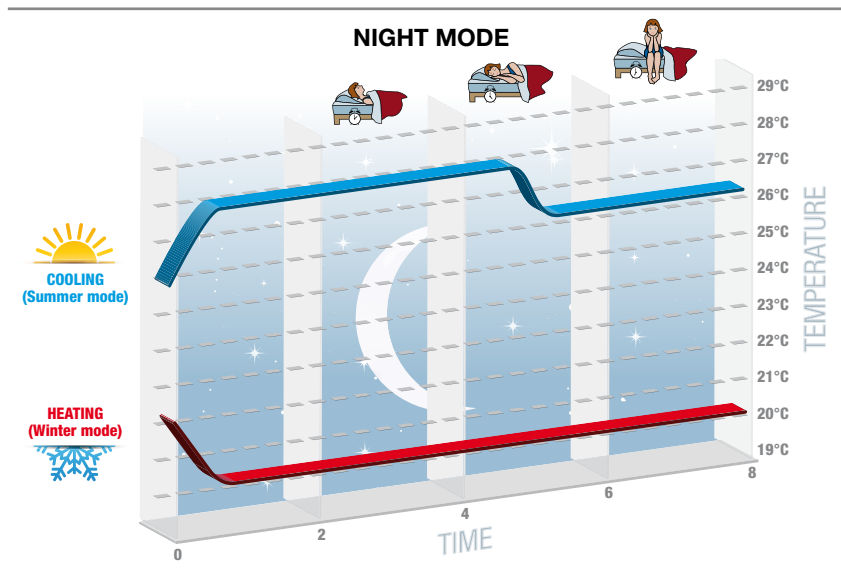



HDM TECHNICAL DATA

Indoor units		AW-HDM009-N91	AW-HDM012-N91	AW-HDM018-N91	AW-HDM024-N91
Outdoor units		AW-YHDM009-H91	AW-YHDM012-H91	AW-YHDM018-H91	AW-YHDM024-H91
Phase		Single phase	Single phase	Single phase	Single phase
COOLING					
Rated power (min./max.)	kW	2.6 (0.8-3.4)	3.6 (1.0-4.2)	5.2 (1.3-6.8)	7.0 (2.2-8.5)
Pdesignc	kW	2,6	3,6	5,2	7,0
Rated power input	kW	0.80	1.11	1.61	2.16
SEER/Energy label		6.2/A++	6.8/A++	6.8/A++	7.1/A++
Operating limits	°C	-10°/46° Dry bulb			
HEATING					
Rated power (min./max.)	kW	3.4 (1.0-4.6)	4.2 (1.1-5.4)	6.0 (1.4-6.9)	8.1 (2.4-10.0)
Pdesignh	kW	2,4	3,2	5,2	5,6
Rated power input	kW	0.91	1.13	1.61	2.18
SCOP/Energy label (average climate)		4.0/A+	4.0/A+	4.0/A+	4.0/A+
SCOP/Energy label (warmer climate)		4.90/A++	4.60/A+++	5.30/A+++	5.30/A+++
Operating limits	°C	-15°/24° Dry bulb			
INDOOR UNIT					
Sound pressure level to 1 m (VL/LS/MS/HS)	dB(A)	20/28/32/35	21/29/33/36	28/35/40/44	30/37/43/47
Sound power level	dB(A)	52	54	57	60
Airflow	m³/h	500	550	1000	1200
Dehumidification	l/h	1,2	1,6	2,0	2,8
Outline dimensions (WxHxD)	mm	820x280x195	820x280x195	1008x318x225	1125x335x240
Package dimensions (WxHxD)	mm	909x355x279	909x355x279	1085x403x329	1206x418x342
Net weight/Gross weight	kg	8.8/11	8.8/11	11.6/14.4	14/17.5
Part number		7SP023090	7SP023091	7SP023092	7SP023093
OUTDOOR UNIT					
Sound pressure level to 1 m	dB(A)	46/47	46/47	51/52	52/53
Sound power level	dB(A)	60/61	61/62	63/64	65/66
Airflow	m³/h	1900	1900	2500	2900
Compressor type		Rotary DC Inverter	Rotary DC Inverter	Rotary DC Inverter	Rotary DC Inverter
Outline dimensions (WxHxD)	mm	780x540x245	780x540x245	820x614x338	890x697x353
Package dimensions (WxHxD)	mm	920x620x351	920x620x351	963x685x413	1046x780x460
Net weight/Gross weight	kg	27/30	28/31	37.8/41.5	51/56
Part number		7SP062945	7SP062946	7SP062947	7SP062948
POWER SUPPLY					
Phase/Tension/Frequency		1P/230V/50Hz	1P/230V/50Hz	1P/230V/50Hz	1P/230V/50Hz
Power supply side		Outdoor	Outdoor	Outdoor	Outdoor
Power cable section	mm²	3x1.5	3x1.5	3x1.5	3x2.5
Fuse rating am (D curve)	A	6.7	7.1	10.6	13
Electrical connections	mm²	5x1.5	5x1.5	5x1.5	5x2.5
PIPE LINE					
Suction pipe diameter	inches	1/4"	1/4"	1/4"	1/4"
Liquid pipe diameter	inches	3/8"	3/8"	1/2"	1/2"
Max. length	m	15	15	25	25
Max. height	m	10	10	15	15
Refrigerant / GWP		R32/675	R32/675	R32/675	R32/675
Charge	kg	0.7	0.72	0.95	1.2
Additional charge	g/m	20	20	20	20

COMBINATIONS

Indoor unit	Compatible with outdoor unit	
	Monosplit	Multisplit
<p>High wall</p> <p>HDM 9 to 18</p> 	<p>YHDM 9 to 18</p> 	<p>YDZA</p> 
<p>HDM 24</p> 	<p>YHDM 24</p> 	<p>YDZA</p> 

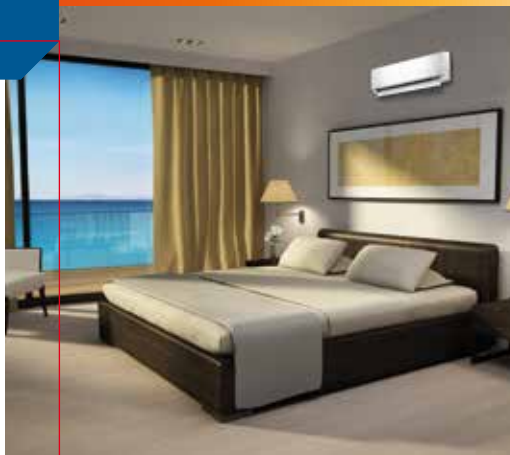

UPGRADE

+ PRODUCTS

- Competitive and multi matching solution.
- Silent heat pump.
- Connected solution (WiFi).



FEATURES

TECHNOLOGY:



AIR QUALITY / CLEAN:



USER FUNCTIONS:



INSTALLER FUNCTIONS:



- High efficiency (SCOP higher than 4 and SEER higher than 6): energy savings.
- Comfort "I Feel": temperature sensor in RC08C remote control.
- Reduced energy consumption using the hot mode alone.
- High wall with digital display (mode, temperature ...).



Refrigerant leakage detection alarm system

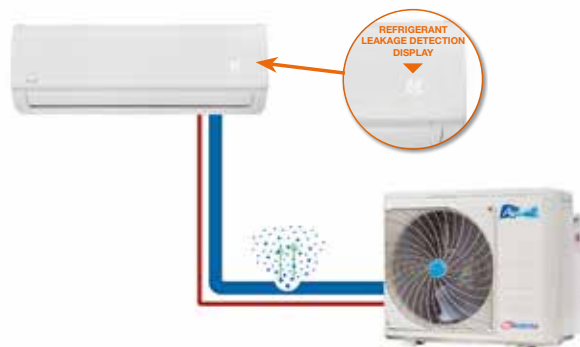

OPTIONS

Accessory	Part number	Photo	Function
Wired single control RCW8	7ACEL1706		Mode, fan speed, timer ON/OFF, temperature and swing.
Test tool for high wall	7ACEL1710		Easy viewing of system parameters, failure records and parameter adjustments.
Additional multi function board	7ACEL1761		ON/OFF, alarm output, centralized controller.
Air Net WiFi Module	7ACEL1744		Control air conditioners with your mobile phone, tablet or computer with wireless router and internet.



HKD TECHNICAL DATA



Indoor units		AWSI-HKD009-N11	AWSI-HKD012-N11	AWSI-HKD018-N11	AWSI-HKD024-N11
Outdoor units		AWAU-YKD009-H11	AWAU-YKD012-H11	AWAU-YKD018-H11	AWAU-YKD024-H11
Phase		Single phase	Single phase	Single phase	Single phase
COOLING					
Rated power (min./max.)	kW	2.65 (1.0 -3.2)	3.54(1.08-4.1)	5.0(1.8-6.1)	6.8(2.7-7.8)
Pdesignc	kW	2.65	3.54	5.0	6.8
Rated power input	kW	0.775	1.096	1.548	2.411
SEER/Energy label		6.1 / A++	6.1 / A++	6.5 / A++	6.1 / A++
Operating limits	°C	-15°/50° Dry bulb			
HEATING					
Rated power (min./max.)	kW	2.7 (0.82-3.3)	3.2 (0.9-4.2)	5.0 (1.4-6.7)	7.3 (1.6-8.7)
Pdesignh (average climate)	kW	2.2	2.3	4.2	5.5
Pdesignh (warmer climate)	kW	2.8	2.9	4.4	6.3
Rated power input	kW	0.728	0.863	1.348	2.274
SCOP/Energy label (average climate)		4 / A+	4.0 / A+	4.0 / A+	4.0 / A+
SCOP/Energy label (warmer climate)		5.1 / A+++	5.3 / A+++	5.1 / A+++	5.1 / A+++
Operating limits	°C	-15°/30° Dry bulb			
Power @ -10°C	kW	2.70	3.00	4.20	6.40
Power @ -15°C	kW	2.30	2.50	3.60	5.80
INDOOR UNIT					
Sound pressure level to 1 m (VL/LS/MS/HS)	dB(A)	23/29/34/38	24/33/37/42	24/32/36/42	32/35/40/44
Sound power level	dB(A)	54	54	57	60
Airflow (VL/LS/MS/HS)	m³/h	270/320/420	370/470/570	540/680/840	640/800/980
Dehumidification	l/h	1.0	1.2	1.7	2.4
Outline dimensions (WxHxD)	mm	715x285x194	805x285x194	957x302x213	1040x327x220
Package dimensions (WxHxD)	mm	780x360x270	870x360x270	1035x380x295	1120x310x405
Net weight/Gross weight	kg	6.8/8.9	7.2/9.6	9.5/12.5	11.9/15.2
Part number		7SP023054	7SP023055	7SP023056	7SP023057
OUTDOOR UNIT					
Sound pressure level to 1 m	dB(A)	51	53	55	59
Sound power level	dB(A)	61	61	65	66
Airflow	m³/h	1800	1800	2100	2700
Compressor type		Rotary DC Inverter	Rotary DC Inverter	Rotary DC Inverter	Rotary DC Inverter
Outline dimensions (WxHxD)	mm	770x555x300	770x555x300	800x554x333	845x702x363
Package dimensions (WxHxD)	mm	900x585x345	900x585x345	920x615x390	965x755x395
Net weight/Gross weight	kg	25.2/27.4	25.5/27.7	37.8/40.5	48.4/51.6
Part number		7SP062910	7SP062911	7SP062952	7SP062913
POWER SUPPLY					
Phase/Tension/Frequency		1P/230V/50Hz	1P/230V/50Hz	1P/230V/50Hz	1P/230V/50Hz
Power supply side		Outdoor	Outdoor	Outdoor	Outdoor
Power cable section	mm²	3x1.5	3x1.5	3x1.5	3x2.5
Fuse rating am (D curve)	A	10	10	16	25
Electrical connections	mm²	5x1.5	5x1.5	5x1.5	5x2.5
PIPE LINE					
Suction pipe diameter	inches	3/8"	3/8"	1/2"	5/8"
Liquid pipe diameter	inches	1/4"	1/4"	1/4"	3/8"
Max. length	m	25	25	30	50
Max. height	m	10	10	20	25
Refrigerant / GWP		R410A/2088	R410A/2088	R410A/2088	R410A/2088
Charge (5 m)	kg	0.8	0.8	1.48	1.85
Additional charge	g/m	15	15	15	15

COMBINATIONS

Indoor unit	Compatible with outdoor unit	
	Monosplit	Multisplit
High wall	YKD	YCZ
HKD 9 to 24		

Ducted range

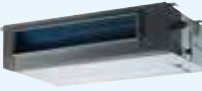

MODEL NAME	Fluid type	Page	kBTU/h kW	12 3.5	18 5	24 7	30 8	36 10	45 12.5	60 16	76 22	95 28
 DUCTED LOW STATIC PRESSURE MONOSPLIT Horizontal or vertical installation	DLF	R410A	24		●	●						
 DUCTED MEDIUM STATIC PRESSURE MONOSPLIT Zone control: Ideal temperature in each room	DLSE	R410A	28		●	●	●	●	●			
 DUCTED MEDIUM STATIC PRESSURE MONO & MULTISPLIT Best seller	DID	R410A	36	●	●	●		●	●	●		



DLF

Horizontal
or vertical
installation

invisible solution

DLSE+VAV

Solution for **the whole house**



Unique solutions



D L F 

One product: 2 installation types

Possibility n°1: VERTICAL INSTALLATION

- Vertical installation with compact dimensions, only 200 mm depth.
- The best solution for replacing radiator.
- The best solution in rooms with no space for ceiling installation.
- Creates a clean and modern design after installation.



Possibility n°2: HORIZONTAL INSTALLATION

- Space saving by minimizing the requirement of ceiling height.
- Ideal solution for hotel and bedroom due to super quiet and extremely compact design.

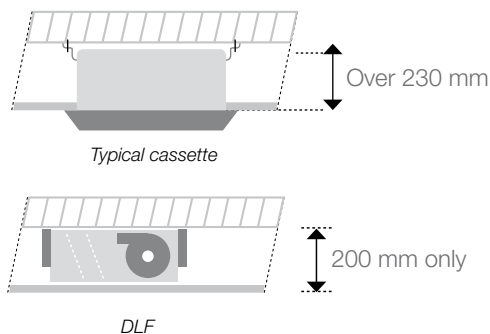

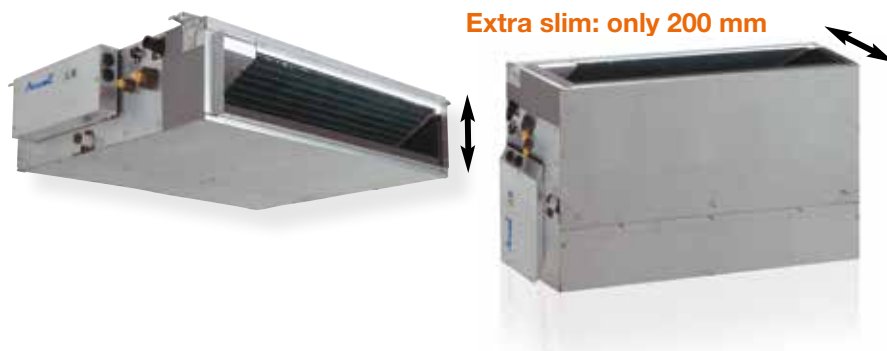

- Comfort "I Feel": temperature sensor in RC08W remote control.
- Compact indoor unit for easy installation in false ceiling.
- Energy savings via variation of the airflow of the outdoor unit.
- Flexible Installation: Horizontally in false ceiling or vertically in wall cabinet.
- Guaranteed energy saving through weekly programming.
- Anti-corrosive treatment that increases the life of the unit.



UPGRADE

+ PRODUCTS

- Horizontal or vertical installation.
- Extra slim.
- Water pump included.



RCW2
included



RC08W (optional)

FEATURES

TECHNOLOGY:



DC INVERTER



R410A FLUID



ELECTRONIC EXPANSION VALVE

AIR QUALITY / CLEAN:



AUTO CLEAN/DRY



FILTER CLEAN INDICATION

USER FUNCTIONS:



I FEEL



SLEEP MODE



QUIET MODE



PROGRAMMABLE TIMER



AUTO RESTART (MEMORY)



REMOTE CONTROL LOCK

INSTALLER FUNCTIONS:



SELF DIAGNOSTIC



INTEGRATED WATER PUMP



ALARM OUTPUT



BMS COMPATIBLE



SERVICE MONITOR TOOL



POWER CONSUMPTION CONTROL



OUTDOOR UNIT NIGHT MODE DRY CONTACT



OUTDOOR UNIT STAND-BY



OUTDOOR UNIT ALARM OUTPUT



DRY CONTACT ON/OFF



TECHNICIAN TEST MODE

BEFORE



AFTER

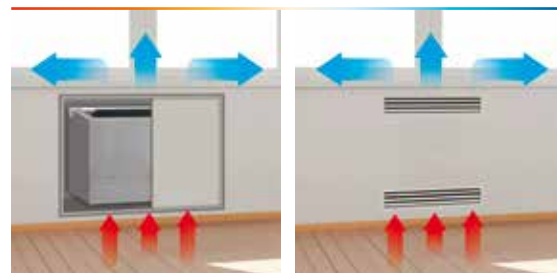

OPTIONS



Accessory	Part number	Photo	Function										
Wireless controller RC08W	7ACEL1741		Operation mode, sleep mode, timer, I Feel, swing, clean mode...										
Duct plenum for DLF 18	7ACVF0516		Round duct connection with the following combination.										
			<table border="1"> <thead> <tr> <th rowspan="2">Indoor model name</th> <th colspan="2">Hoses connection</th> </tr> <tr> <th>Option 1</th> <th>Option 2</th> </tr> </thead> <tbody> <tr> <td>DLF 18</td> <td>3x160mm</td> <td>1x160mm + 1x200mm</td> </tr> <tr> <td>DLF 24</td> <td>4x160mm</td> <td>1x160mm + 1x200mm</td> </tr> </tbody> </table>	Indoor model name	Hoses connection		Option 1	Option 2	DLF 18	3x160mm	1x160mm + 1x200mm	DLF 24	4x160mm
Indoor model name	Hoses connection												
	Option 1	Option 2											
DLF 18	3x160mm	1x160mm + 1x200mm											
DLF 24	4x160mm	1x160mm + 1x200mm											
Duct plenum for DLF 24	7ACVF0517												



DLF TECHNICAL DATA

Indoor units		AWSI-DLF018-N11	AWSI-DLF024-N11
Outdoor units		AWAU-YBDE018-H11	AWAU-YBDE024-H11
Phase		Single phase	Single phase
COOLING			
Rated power (min./max.)	kW	5.0 (1.5-5.8)	7.0 (1.5-7.5)
Pdesignc	kW	5.0	7.0
Rated power input	kW	1.23	1.70
SEER/Energy label		5.4/A	5.6/A+
Operating limits	°C	-10°/46° Dry bulb	
HEATING			
Rated power (min./max.)	kW	5.6 (1.3-6.8)	7.6 (1.5-8.8)
Pdesignh	kW	4.8	7.5
Rated power input	kW	1.52	1.78
SCOP/Energy label (average climate)		3.9/A	3.8/A
SCOP/Energy label (warmer climate)		4.3/A+	4.7/A++
Operating limits	°C	-15°/24° Dry bulb	
Power @ -10°C	kW	5.3	5.4
Power @ -15°C	kW	4.7	4.8
INDOOR UNIT			
Sound pressure level to 1 m (LS/MS/HS)	dB(A)	29/32/35	32/35/39
Sound power level (LS/MS/HS)	dB(A)	48/51/54	56/59/63
Airflow (LS/MS/HS)	m³/h	540/600/710	900/950/1150
External static pressure Range	Pa	0-40	0-40
Dehumidification	l/h	1.8	2.7
Outline dimensions (WxHxD)	mm	750x200x630	1050x200x630
Package dimensions (WxHxD)	mm	890x243x710	1190x243x710
Net weight/Gross weight	kg	21/23	25/28
Part number		7SP022748	7SP022749
OUTDOOR UNIT			
Sound pressure level to 1 m	dB(A)	53	55
Sound power level	dB(A)	65	67
Airflow	m³/h	2500	2750
Compressor type		Twin Rotary DC Inverter	Twin Rotary DC Inverter
Outline dimensions (WxHxD)	mm	900x700x340	900x700x340
Package dimensions (WxHxD)	mm	985x730x435	985x730x435
Net weight/Gross weight	kg	56/58.5	61/63.5
Part number		7SP061886	7SP061887
POWER SUPPLY			
Phase/Tension/Frequency		1P/230V/50Hz	1P/230V/50Hz
Power supply side		Indoor & Outdoor	Outdoor
Power cable section	mm²	3x2.5	3x2.5
Fuse rating am (D curve)	A	20	20
Electrical connections	mm²	4x1.5	4x1.5
PIPE LINE			
Suction pipe diameter	inches	1/2"	5/8"
Liquid pipe diameter	inches	1/4"	3/8"
Max. length	m	30	30
Max. height	m	15	15
Refrigerant / GWP		R410A/2088	R410A/2088
Charge (7,5 m)	kg	1.55	2.3

COMBINATIONS

Indoor unit	Compatible with outdoor unit
Ducted	Monosplit
<p>DLF</p> 	<p>YBDE</p> 



• Unique
solutions

DLSE Plus VAV

Variable Air Volume



Zone control: Ideal temperature in each room

THE SOLUTION DLSE + VAV ALLOWS UP TO 30% SAVINGS (installation and equipment) IN RELATION TO STANDARD SYSTEMS

- Solution de climatisation et chauffage invisible pour toute la maison.
- Très faible niveau sonore.
- Installation peu onéreuse (moins de travail du tubbing...).
- Système à faible coût (1 seule unité intérieure).



ZONE CONTROL FUNCTION

- Smart air conditioning: Controls up to 6 rooms.
- Each zone has a standalone remote control, to control temperature, "I Feel" and ON/OFF.
- Option to define automatic damper movement or manually to keep max. opening position.
- By-pass damper operates according to system load, which ensures air circulation in the indoor unit.
- Auto-mode: automatically recognizes cooling or heating mode.
- Motorized damper with DC step motor for accurate damper position.
- The blowing dampers change their position (open/close), in accordance with the temperature setpoint in each room, which keeps required temperature.

EASY INSTALLATION

- Simple wiring connection by connectors and set up.
- Up to 70m between indoor and outdoor units.
- Monosplit indoor unit: time saving (little tubing).
- Option for installing the control box besides the unit.
- Water pump and overflow switch built in.

Good to know!

Use our design document to select easily your system.
Ask us this helpful file: mkg@airwell-res.com

SPECIAL DESIGN FOR YOUR CONVENIENCE

- Unique V shape coil.
- Extra slim indoor unit (low height: 256 mm only).

STANDARD DESIGN

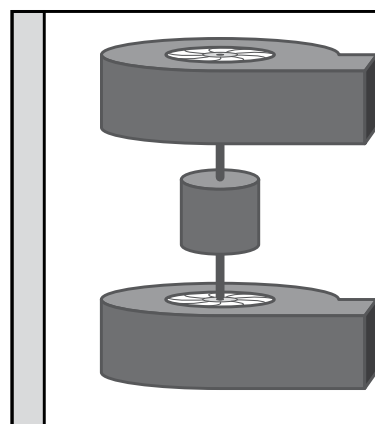
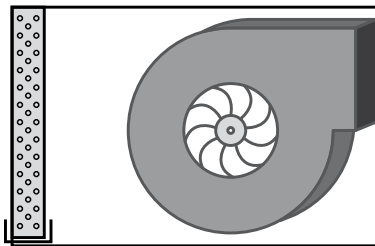

DLSE

Horizontal fan, higher air volume + high static pressure

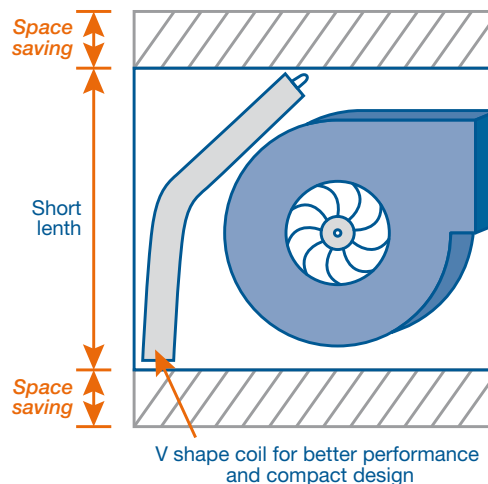
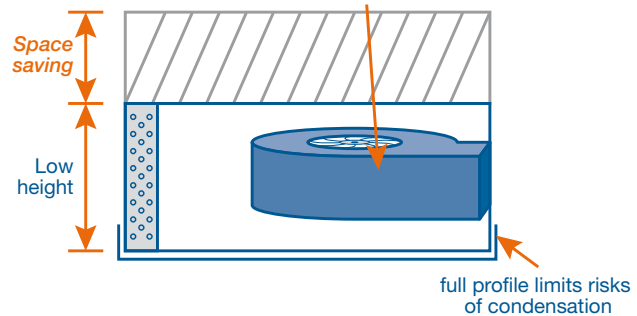

How to order?

- For each installation select first the damper type, round or rectangular.
- The main controller is identical except the set up which is done during the installation.
- After that, select motorized round damper, by-pass damper and plenum (see table below).

ROUND APPLICATION

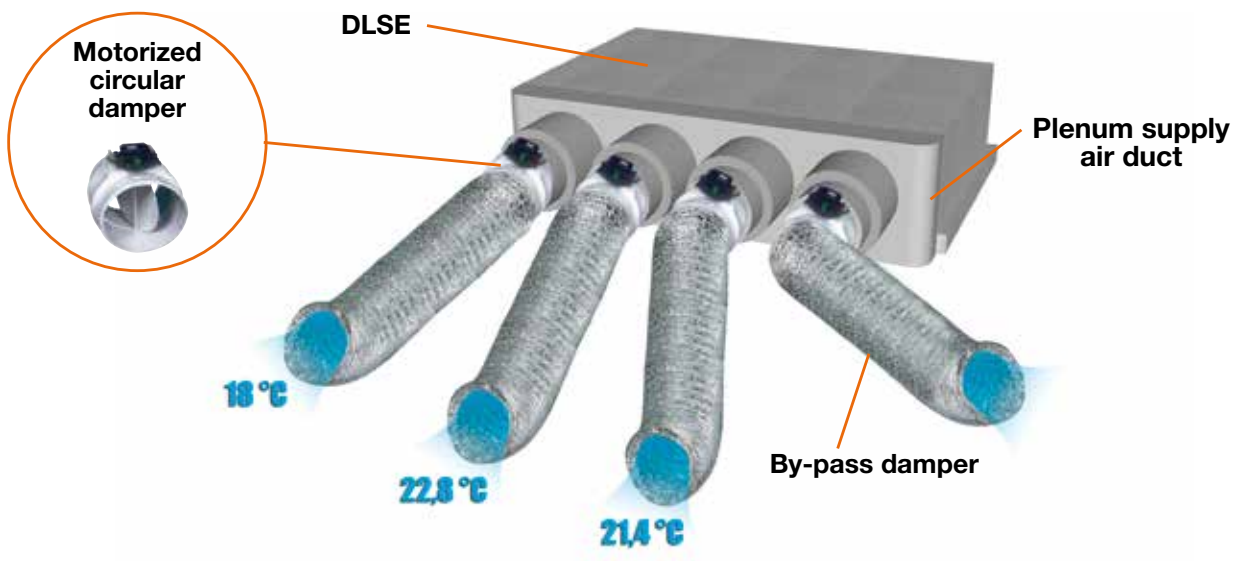

MOTORIZED ROUND TYPE ACCESSORIES

Part description	Part number
DLSE kit (mandatory)	7ACEL1745
Main controller VAV kit (mandatory)	7ACEL1641
Motorized round damper (D=155 mm) kit (Wireless controller C85-R included)	7ACEL1657
Motorized round damper (D=200 mm) kit (Wireless controller C85-R included)	7ACEL1649
Motorized round damper (D=250 mm) kit (Wireless controller C85-R included)	7ACEL1650
Motorized by-pass round damper (D=200 mm) kit (Wireless controller C85-R included)	7ACEL1651
Motorized by-pass round damper (D=250 mm) kit (Wireless controller C85-R included)	7ACEL1652

PLENUM ACCESSORIES: ROUND APPLICATION

Part description	Models	Part number
4 outlets in 200 mm + 1 bypass 200 mm (1 obturator 200 mm included)	DLSE 18/24	7ACVF0130
4 outlets in 200 mm + 2 outlets in 160 mm + 1 bypass in 200 mm (1 obturator 200 mm included)	DLSE 18/24	7ACVF0131
3 outlets in 200 mm + 1 bypass in 200 mm (intake) (2 obturators 200 mm included)	DLSE 18/24	7ACVF0132
4 outlets in 200 mm + 1 bypass in 200 mm (1 obturator 200 mm included)	DLSE 30 and up	7ACVF0133
4 outlets in 200 mm + 2 outlets in 160 mm + 1 bypass 200 mm (1 obturator 200 mm included)	DLSE 30 and up	7ACVF0134
3 sorties in 250 mm+1 bypass in 200 mm (intake) (2 obturators in 250 mm included)	DLSE 30 and up	7ACVF0135

RECTANGULAR APPLICATION

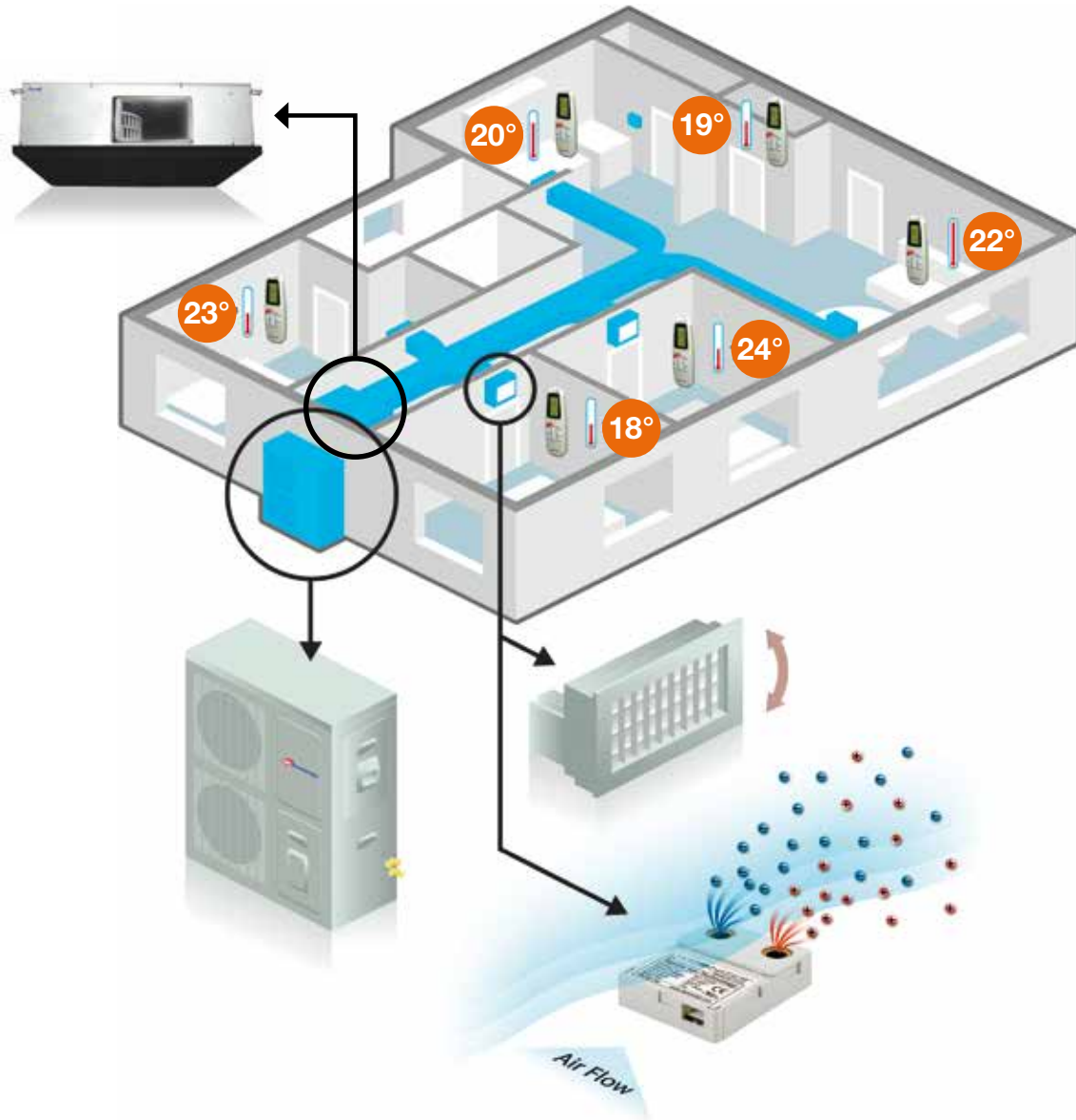

MOTORIZED RECTANGULAR TYPE ACCESSORIES

Part description	Part number
DLSE kit (mandatory)	7ACEL1745
Main controller VAV kit	7ACEL1641
Motorized grill (30 cm x 15 cm) kit (Wireless controller C85-R included)	7ACEL1642
Motorized grill (40 cm x 15 cm) kit (Wireless controller C85-R included)	7ACEL1643
Motorized grill (50 cm x 15 cm) kit (Wireless controller C85-R included)	7ACEL1644
Motorized by-pass damper (40 cm x 15 cm) kit	7ACEL1645
Motorized by-pass damper (50 cm x 15 cm) kit	7ACEL1646
Duct frame profile for grille 150 mm	7ACVF0551
Duct frame profile for grille 300 mm	7ACVF0552
Duct frame profile for grille 400 mm	7ACVF0553
Duct frame profile for grille 500 mm	7ACVF0554
Sterionizer kit for motorized grill	7ACEL1655

Handwriting practice area consisting of 30 horizontal dotted lines.

DC Inverter
Cooling & heating

DLSE+VAV DUCTED MEDIUM STATIC PRESSURE MONOSPLIT



- Comfort "I Feel": temperature sensor in RC08W remote control.
- Energy savings via variation of the airflow of the outdoor unit.
- A set temperature in each room with a single monosplit system.
- Guaranteed energy saving through weekly programming.
- Anti-corrosive treatment that increases the life of the unit.

Unique solutions

A⁺⁺

UPGRADE

+ PRODUCTS

- Variable Air Volume Solution.
- Water pump included.
- Super quiet.



RCW2 included



C85-R (included with damper)



RC08W (optional)

FEATURES

TECHNOLOGY:



DC INVERTER



R410A FLUID



ELECTRONIC EXPANSION VALVE

USER FUNCTIONS:



I FEEL



SLEEP MODE



QUIET MODE



PROGRAMMABLE TIMER



AUTO RESTART (MEMORY)



REMOTE CONTROL LOCK

INSTALLER FUNCTIONS:



SELF DIAGNOSTIC



ALARM OUTPUT



BMS COMPATIBLE



SERVICE MONITOR TOOL



POWER CONSUMPTION CONTROL



OUTDOOR UNIT NIGHT MODE DRY CONTACT (DLSE 24-30-36)



OUTDOOR UNIT STAND-BY (DLSE 24-30-36)



OUTDOOR UNIT ALARM OUTPUT (DLSE 24-30-36)



DRY CONTACT ON/OFF



TECHNICIAN TEST MODE



GLOBAL AND INVISIBLE SOLUTION FOR YOUR HOME

Indoor unit

Outdoor unit

OPTIONS



Accessory	Part number	Photo	Function
Wireless controller RC08W	7ACEL1741		Operation mode, sleep mode, timer, I Feel, swing, clean mode...

See option VAV accessories on page 31.

DLSE TECHNICAL DATA

Indoor units		AWSI-DLSE018-N11	AWSI-DLSE024-N11	AWSI-DLSE030-N11	AWSI-DLSE036-N11		AWSI-DLSE043-N11	
Outdoor units		AWAU-YBDE018-H11	AWAU-YBDE024-H11	AWAU-YBDE030-H11	AWAU-YBD036-H11	AWAU-YBD036-H13	AWAU-YBD042-H11	AWAU-YAD042-H13
Phase		Single phase	Single phase	Single phase	Single phase	Three phases	Single phase	Three phases
COOLING								
Rated power (min./max.)	kW	5.0 (2.3-5.9)	6.8 (1.7-7.4)	7.5 (2.8-8.4)	9.5 (4.8-12.5)	9.5 (4.8-12.5)	12.5 (4.5-14.5)	12.5 (4.5-14.5)
Pdesignc	kW	5.0	6.8	7.5	9.5	9.5	-	-
Rated power input	kW	1.22	1.93	2.02	3.47	3.04	3.73	3.56
SEER/Energy label		5.8/A+	5.4/A	6.2 / A++	6.2 / A++	4.7/B	3.35/A	3.51/A
Operating limits	°C	-10°/46° Dry bulb						
HEATING								
Rated power (min./max.)	kW	5.6 (1.9-7.5)	7.6 (1.8-8.5)	8.6 (2.8-9.4)	10.5	11.6 (4.9-12.5)	14.0 (4.5-16.0)	14.0 (4.5-16.0)
Pdesignh	kW	5.5	7.5	8.6	9.5	10.5	-	-
Rated power input	kW	1.35	1.88	2.26	2.46	3.00	4.1	3.99
SCOP/Energy label (average climate)		3.9/A	3.8/A	4.0 / A+	4.0 / A+	3.9/A	3.41/B	3.51/B
SCOP/Energy label (warmer climate)		4.6/A+	4.9/A++	5.2/A+++	4.8/A++	4.7/A++	-	-
Operating limits	°C	-15°/24° Dry bulb						
Power @ -10°C	kW	5.3	5.8	7.1	6.9	8.9	9.3	9.3
Power @ -15°C	kW	4.7	5.2	6.3	6.2	8.0	8.3	8.3
INDOOR UNIT								
Sound pressure level to 1 m (LS/MS/HS/SS)	dB(A)	35/38/41/43	38/42/45/48	39/43/46/48	41/45/46/48	41/45/46/48	42/46/53	42/46/53
Sound power level (LS/MS/HS/SS)	dB(A)	52/55/58/60	55/59/62/65	56/60/63/65	56/61/63/65	56/61/63/65	57/61/70	57/61/70
Airflow (LS/MS/HS/SS)	m³/h	740/875/1060/1150	870/1090/1220/1410	950/1140/1290/1410	1290/1580/1670/1750	1290/1580/1670/1750	1315/1530/2025	1315/1530/2025
External static pressure Range	Pa	25 (25-60)	25 (25-80)	25 (25-80)	37 (37-100)	37 (37-100)	50 (50-100)	50 (50-100)
Dehumidification	l/h	1.5	2.3	2.7	3.5	4.6	3.3	3.8
Outline dimensions (WxHxD)	mm	790x256x749	790x256x749	790x256x749	854x297x816	854x297x816	854x297x816	854x297x816
Package dimensions (WxHxD)	mm	960x300x855	960x300x855	960x300x855	1005x345x915	1005x345x915	1005x345x915	1005x345x915
Net weight/Gross weight	kg	29/31.5	30/32.5	31/33.5	33/35.5	33/35.5	33/35.5	33/35.5
Part number		7SP032154	7SP032155	7SP032156	7SP032157	7SP032157	7SP032087	7SP032087
OUTDOOR UNIT								
Sound pressure level to 1 m	dB(A)	53	55	56	58	58	58	58
Sound power level	dB(A)	65	67	68	69	69	70	70
Airflow	m³/h	2500	2750	3400	4150	4150	5700	5700
Compressor type		Twin Rotary DCI	Twin Rotary DCI	Twin Rotary DCI	Twin Rotary DCI	Twin Rotary DCI	Scroll DCI	Twin Rotary DCI
Outline dimensions (WxHxD)	mm	900x700x340	900x700x340	900x860x340	900x970x340	900x970x340	900x1250x340	900x1250x340
Package dimensions (WxHxD)	mm	985x730x435	985x730x435	985x905x435	985x1020x435	985x1020x435	980x1400x420	980x1400x420
Net weight/Gross weight	kg	56/58.5	61/63.5	66 / 68.5	80 / 82.8	85/87.8	110/121	110/121
Part number		7SP061886	7SP061887	7SP061922	7SP061923	7SP061900	7SP061815	7SP061757
POWER SUPPLY								
Phase/Tension/Frequency		1P/230V/50Hz	1P/230V/50Hz	1P/230V/50Hz	1P/230V/50Hz	3P/400V/50Hz	1P/230V/50Hz	3P/400V/50Hz
Power supply side		Ind. & Out.	Outdoor	Outdoor	Outdoor	Outdoor	Outdoor	Outdoor
Power cable section	mm²	3x2.5	3x2.5	3x2.5	3x4.0	5x2.5	3x6.0	5x2.5
Fuse rating am (D curve)	A	20	20	20	25	3x16	32	3x16
Electrical connections	mm²	4x1.5	4x1.5	4x1.5	3x1.5 + 2x0.75	3x1.5 + 2x0.75	3x1.5 + 2x0.75	3x1.5 + 2x0.75
PIPE LINE								
Suction pipe diameter	inches	1/2"	5/8"	5/8"	5/8"	5/8"	3/4"	3/4"
Liquid pipe diameter	inches	1/4"	3/8"	3/8"	3/8"	3/8"	3/8"	3/8"
Max. length	m	30	30	50	70	70	70	70
Max. height	m	15	15	25	30	30	30	30
Refrigerant / GWP		R410A/2088	R410A/2088	R410A/2088	R410A/2088	R410A/2088	R410A/2088	R410A/2088
Charge (precharge length)	kg	1.55 (15m)	2.3 (15m)	2.1 (15m)	2.5 (30m)	2.5 (30m)	3.3 (30m)	3.2 (30m)
Additional charge	g/m	35	35	50	30	30	40	40

COMBINATIONS

Indoor unit	Compatible with outdoor unit
Ducted	Monosplit
DLSE 18 	YBDE 
DLSE 24 to 43 	YBDE 

• Unique
solutions

DID 

Twin application

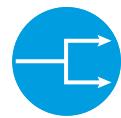

TWIN APPLICATION

The twin application is used mainly in big open space where the total space area is controlled by one controller only for 2 units. Airwell twin design allows to connect two similar indoor units to one common outdoor unit. The two indoor units are working in a same mode and set up only once, one indoor unit used as master.

The most cost saving solution for single-area spaces:

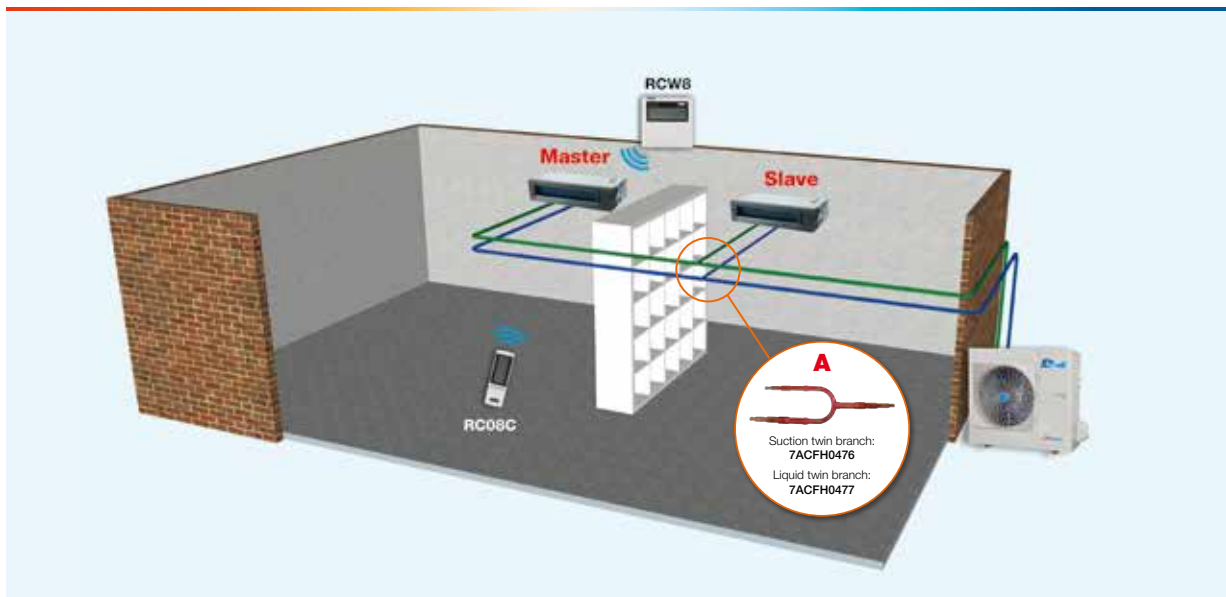

- Simple installation by having one refrigerant and control system.
- Space saving by using one outdoor unit instead of two.
- Low cost installation.
- Simple control, one control station for big space.
- Option to control by wireless or wired controller.
- Ducted or cassette application.



	Indoor units	Outdoor units
Twin system	DID018 + DID018	YMD036
	DID024 + DID024	YMD048

Tubeing & charge instructions	YMD036	YMD048
Pipe diameter (liquid-gas) (inches)	3/8"-5/8"	
Max. length (m)	30	50
Max. difference in branch length (m)	10	
Max. height drop between indoor units (m)	0.5	
Max. height drop between indoor and outdoor units (m)	20	
Max. branch length (m)	15	

MANDATORY ACCESSORIES

Accessory	Part number	Photo	Description	Function
Branch gas	7ACFH0476		Twin branch suction	Tube branch to collect all suction lines. Mandatory for Twin application.
Branch liquid	7ACFH0477		Twin branch liquid	Tube branch to collect all liquid lines. Mandatory for Twin application.



DID 012



DID 018-060



UPGRADE

+ PRODUCTS

- Twin application.
- Many options.
- Compatible in monosplit and multisplit.
- G1 filter.



RCW8
included



RC08C
(optional)



RCW6
(optional)

FEATURES

TECHNOLOGY:



REDUNDANCY
FUNCTION

AIR QUALITY / CLEAN:



FRESH AIR

USER FUNCTIONS:



INSTALLER FUNCTIONS:

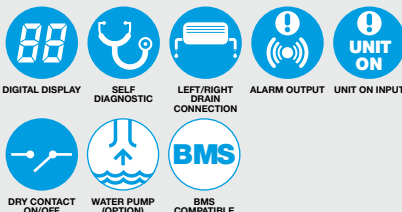

- Comfort "I Feel": temperature sensor in the remote control RC08C.
- Designed for easy maintenance and installation.
- Interface dedicated to the installer for commissioning and maintenance.
- Reduced energy consumption using the heat mode alone.
- Optimisation of the stock thanks to a multi-range external group (YMD).
- Air intake option from the back or bottom.



OPTIONS

Accessory	Part number	Photo	Function / Description
Wireless controller RC08C	7ACEL1740		Timer, eco mode, "Follow me" option, swing, technician mode, heating only mode.
Wired single control RCW6	7ACEL1704		Mode, fan speed, real time, timer, temperature, weekly timer and swing.
Central controller RCW16	7ACEL1707		Controls up to 64 indoor units with individual setting failure codes indication, ON-OFF dry contact, last operation memory, Modbus.
BMS gateway	7ACEL1708		Maximum 1024 units could be connected (16 gateways).
Insulated air duct plenum	7ACVF0136		2 ducts DN160. For DID 12.
	7ACVF0137		3 ducts DN 160. For DID 18.
	7ACVF0138		3 ducts DN 160. For DID 24.
	7ACVF0140		3 ducts DN 160. For DID 36/48/60.









All sizes except DID 048-060

DID TECHNICAL DATA

Indoor unit		AWSI-DID012-N11	AWSI-DID018-N11	AWSI-DID024-N11	AWSI-DID036-N11	AWSI-DID036-N11	AWSI-DID048-N11	AWSI-DID060-N11
Outdoor unit		AWAU-YMD012-H11	AWAU-YMD018-H11	AWAU-YMD024-H11	AWAU-YMD036-H11	AWAU-YMD036-H13	AWAU-YMD048-H13	AWAU-YMD060-H13
Phase		Single phase	Single phase	Single phase	Single phase	Three phases	Three phases	Three phases
COOLING								
Rated power (min./max.)	kW	3.5 (0.5-4.1)	5.1 (0.8-6.1)	7 (1.2-8.2)	10.0 (2.9-12.0)	10.0 (2.9-12.0)	14.0 (4.1-16.4)	16 (5.0-18.1)
Pdesignnc	kW	3.5	5.1	7	10.0	10.0	14.0	16
Rated power input	kW	1.300	1.579	2.167	3.817	3.817	4.965	6.612
SEER/Energy label		5.6/A++	6.3/A++	6.1/A++	6.1/A++	6.1/A++	6.1/A++	5.6/A+
Operating limits	°C	-20°/50° DB	-15°/50° Dry bulb					
HEATING								
Rated power (min./max.)	kW	3.80 (0.9-4.6)	5.8 (0.9-7.0)	7.3 (1.2-8.6)	11.5 (2.6-13.2)	11.5 (2.6-13.2)	16 (4.3-18.1)	18.0 (5.3-20.5)
Pdesignnh (average climate)	kW	2.6	4.7	6	10.2	10.0	12	12.2
Pdesignnh (warmer climate)	kW	3.4	5	6	10.5	10.5	12.2	12.4
Rated power input	kW	1.200	1.518	1.911	3.091	3.091	4.301	5.263
SCOP/Energy label (average climate)		4.0/A+	4.0/A+	4.0/A+	4.0/A+	4.0/A+	4.0/A+	4.0/A+
SCOP/Energy Label (warmer climate)		4.9/A++	5.1/A+++	5.1/A+++	5.1/A+++	5.1/A+++	5.1/A+++	5.1/A+++
Operating limits	°C	-20°/24° DB	-15°/24° Dry bulb					
Power @ -10°C	kW	2.4	4.8	7.6	9.8	9.5	12.9	14.1
Power @ -15°C	kW	1.9	3.8	6.2	7.6	7.6	10.1	12.3
INDOOR UNIT								
Sound pressure level to 1 m (LS/MS/HS)	dB(A)	27/34/40	38/40/42	38/40/42	38/40/42	42/44/46	48/50/52	54/56/58
Sound power level	dB(A)	60	59	62	63	63	69	74
Airflow (LS/MS/HS)	m³/h	300/480/600	690/850/980	780/1000/1200	920/1100/1400	920/1100/1400	1450/1740/2100	1800/2150/2500
External static pressure Range	Pa	25 (0-60)	25 (0-100)	25 (0-100)	37 (0-120)	37 (0-120)	50 (0-160)	50 (0-160)
Dehumidification	l/h	1.5	2	2.5	3.8	3.8	4.5	5.5
Outline dimensions (WxHxD)	mm	700x200x450	880x210x674	1100x774x249	1360x249x774	1360x249x774	1200x300x874	1200x300x874
Package dimensions (WxHxD)	mm	860x275x540	1070x270x725	130x305x805	1570x305x805	1570x305x805	1405x355x915	1405x355x915
Net weight/Gross weight	kg	18/22	25.4/31	31.7/39.1	40.2/48.4	40.2/48.4	46/55.2	46/55.2
Part number		7SP032190	7SP032166	7SP032167	7SP032168	7SP032168	7SP032169	7SP032170
OUTDOOR UNIT								
Sound pressure level to 1 m	dB(A)	56	54	60	61	61	63	63
Sound power level	dB(A)	63	65	65	67	68	72	75
Airflow	m³/h	2000	2100	2700	4300	4300	6800	7200
Compressor type		Rotary DCI	Rotary DCI	Twin Rotary DCI	Twin Rotary DCI	Twin Rotary DCI	Twin Rotary DCI	Twin Rotary DCI
Outline dimensions (WxHxD)	mm	800x554x333	800x554x333	845x702x363	946x810x410	946x810x410	952x1333x415	952x1333x415
Package dimensions (WxHxD)	mm	920x615x390	920x615x390	965x765x396	1090x865x500	1090x865x500	1095x1470x500	1095x1470x500
Net weight/Gross weight	kg	29.9/32.6	35.5/38.4	49/51.5	67.2/72.9	78.9/83.9	108.1/121.2	112.8/126
Part number		7SP062970	7SP062892	7SP062893	7SP062895	7SP062896	7SP062899	7SP062900
POWER SUPPLY								
Phase/Tension/Frequency		1P/230V/50Hz	1P/230V/50Hz	1P/230V/50Hz	1P/230V/50Hz	3P/400V/50Hz	3P/400V/50Hz	3P/400V/50Hz
Power supply side		Outdoor	Ind. & Out.	Ind. & Out.	Ind. & Out.	Ind. & Out.	Ind. & Out.	Ind. & Out.
Power cable section	mm²	3x1.5	3x1.0+3x2.5	3x1.0+3x2.5	3x1.0+3x4.0	3x1.0+5x2.5	3x1.0+5x2.5	3x1.0+5x2.5
Fuse rating am (D curve)	A	16	10+16	10+25	10+30	10+20	10+25	10+25
Electrical connections	mm²	4x1.0	2x0.5	2x0.5	2x0.5	2x0.5	2x0.5	2x0.5
PIPE LINE								
Suction pipe diameter	inches	3/8"	1/2"	5/8"	5/8"	5/8"	5/8"	5/8"
Liquid pipe diameter	inches	1/4"	1/4"	3/8"	3/8"	3/8"	3/8"	3/8"
Max. length	m	25	30	50	65	65	65	65
Max. height	m	10	20	25	30	30	30	30
Refrigerant / GWP		R410A/2088	R410A/2088	R410A/2088	R410A/2088	R410A/2088	R410A/2088	R410A/2088
Charge (5 m)	kg	1.05	1.78	1.95	3.2	3.2	4	4.3
Additional charge	g/m	15	15	30	30	30	30	30

COMBINATIONS

Indoor unit	Compatible with outdoor unit	
	Ducted	Multisplit
DID 12 	YMD 	Y CZ 
DID 18 to 36 	YMD 	
DID 48 & 60 	YMD 	

Cassette range



MODEL NAME	Fluid type	Page	kBTU/h kW	9 2.5	12 3.5	18 5	24 7	36 10	48 12.5
UPGRADE									
 CASSETTE MONOSPLIT/ MULTISPLIT ONLY SIZES 9, 12 & 18 Twin system	CCD	R410A	42	60 x 60	60 x 60	60 x 60	90 x 90	90 x 90	90 x 90

- Distribution of the air flow thanks to the **Twin system**
- **1 outdoor unit only**



• Unique
solutions

CCD 

Twin application



TWIN APPLICATION

The twin application is used mainly in big open space where the total space area is controlled by one controller only for 2 units. Airwell twin design allows to connect two similar indoor units to one common outdoor unit. The two indoor units are working in a same mode and set up only once, one indoor unit used as master.

The most cost saving solution for single-area spaces:

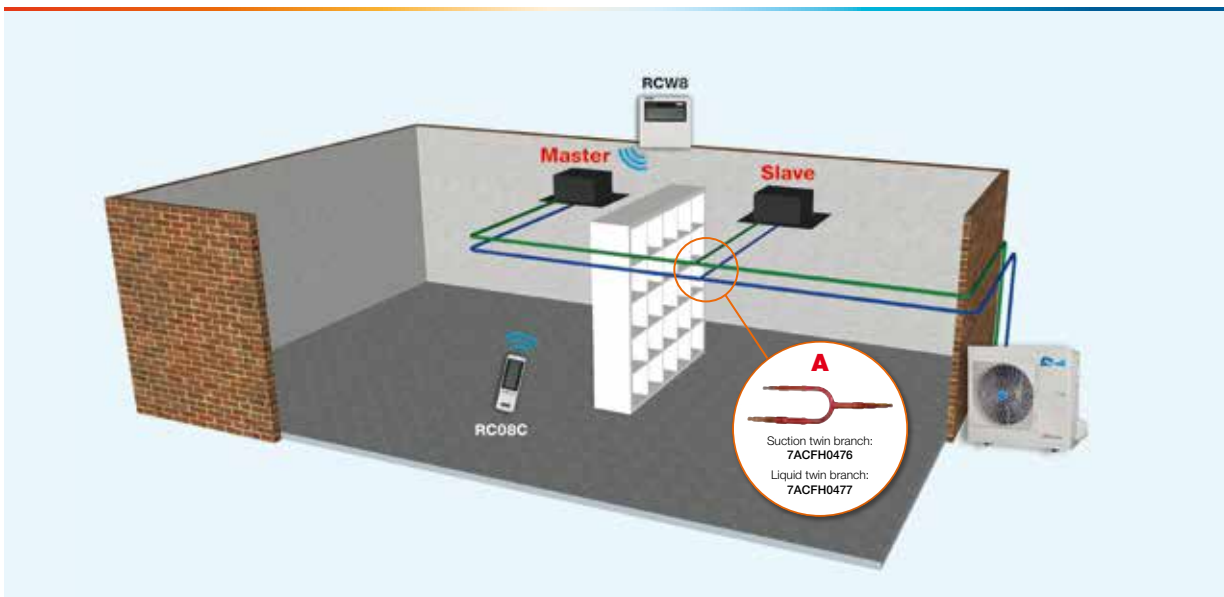

- Simple installation by having one refrigerant and control system.
- Space saving by using one outdoor unit instead of two.
- Low cost installation.
- Simple control, one control station for big space.
- Option to control by wireless or wired controller.
- Ducted or cassette application.



	Indoor units	Outdoor units
Twin system	CCD018 + CCD018	YMD036
	CCD024 + CCD024	YMD048

Tubeing & charge instructions	YMD036	YMD048
Pipe diameter (liquid-gas) (inches)	3/8"-5/8"	
Max. length (m)	30	50
Max. difference in branch length (m)	10	
Max. height drop between indoor units (m)	0.5	
Max. height drop between indoor and outdoor units (m)	20	
Max. branch length (m)	15	

MANDATORY ACCESSORIES

Accessory	Part number	Photo	Description	Function
Branch gas	7ACFH0476		Twin branch suction	Tube branch to collect all suction lines. Mandatory for Twin application.
Branch liquid	7ACFH0477		Twin branch liquid	Tube branch to collect all liquid lines. Mandatory for Twin application.

DC Inverter
Cooling & heating

CCD CASSETTE MONOSPLIT MULTISPLIT Only sizes 9, 12 & 18



600x600 and 900x900

UPGRADE



TWIN APPLICATION

+ PRODUCTS

- 360° flow.
- Twin application.
- Fresh air intake (for models 24 to 48).
- Water pump included.
- G1 filter.



RC08C
included



RCW6
(optional)



RCW8
(optional)

FEATURES

TECHNOLOGY:



REDUNDANCY
FUNCTION

AIR QUALITY / CLEAN:



USER FUNCTIONS:



INSTALLER FUNCTIONS:

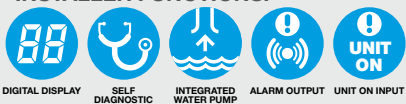

CCD 009-012-018

CCD 024-036-048



- Comfort "I Feel": temperature sensor in RC08C remote control.
- Multisplit application available in sizes 9X, 12 and 18X (see specific part numbers on page 60).
- Compatible with a centralized remote control.
- Interface dedicated to the installer for commissioning and maintenance.
- Reduced energy consumption using the heat mode alone.
- Inventory optimization thanks to a multi-range outdoor unit (YMD).

360 DEGREE FLOW WITH ROUND CORNERS



OPTIONS

Accessory	Part number	Photo	Function
Wired single control RCW6	7ACEL1704		Mode, fan speed, real time, timer, temperature, weekly timer and swing.
Wired single control RCW8	7ACEL1706		Mode, fan speed, timer ON/OFF, temperature and swing.
Central controller RCW16	7ACEL1707		Controls up to 64 indoor units with individual setting failure codes indication, ON-OFF dry contact, last operation memory, Modbus.
BMS gateway	7ACEL1708		Maximum 1024 units could be connected (16 gateways).







CCD TECHNICAL DATA

ONLY MULTI
CONFIGURATION

Indoor unit		AWSI- CCD009X-N11	AWSI- CCD012-N11	AWSI- CCD018-N11	AWSI- CCD024-N11	AWSI- CCD036-N11	AWSI- CCD036-N11	AWSI- CCD048-N11
Outdoor units		-	AWAU- YMD012-H11	AWAU- YMD018-H11	AWAU- YMD024-H11	AWAU- YMD036-H11	AWAU- YMD036-H13	AWAU- YMD048-H13
Phase		Single phase						
COOLING								
Rated power (min./max.)	kW	2.6 (0.8-3.3)	3.5 (0.8-4.1)	5.1 (0.8-6.1)	6.8 (1.2-8.2)	10.5 (2.9-12.0)	10.5 (2.9-12.0)	14.0 (4.0-16.1)
Pdesignc	kW		3.5	5.1	6.8	10.5	10.5	14.0
Rated power input	kW		0.9	1.579	2.105	4.008	4.008	5.344
SEER/Energy label			6.8/A++	6.3/A++	6.1/A++	6.1/A++	6.1/A++	5.6/A+
Operating limits	°C	-15°/50° Dry bulb						
HEATING								
Rated power (min./max.)	kW	2.9 (0.85-3.7)	4.1 (0.5-4.4)	5.6 (0.9-7.0)	7.6 (1.2-8.6)	11.2 (2.6-13.2)	11.2 (2.6-13.2)	15.5 (4.2-17.6)
Pdesignh (average climate)	kW		3.5	4.8	5.8	9.8	10.0	11.5
Pdesignh (warmer climate)	kW		3.6	5	5.8	10.5	10.5	11.6
Rated power input	kW		0.995	1.509	2.049	3.216	3.216	4.532
SCOP/Energy label (average climate)			4.0/A+	4.0/A+	4.0/A+	4.0/A+	4.0/A+	4.0/A+
SCOP/Energy Label (warmer climate)			5.1/A+++	5.1/A+++	5.1/A+++	5.1/A+++	5.1/A+++	5.1/A+++
Operating limits	°C	-15°/24° Dry bulb						
INDOOR UNIT								
Sound pressure level to 1 m (LS/MS/HS)	dB(A)	32/36/39	34/38/42	36/40/44	42/44/47	48/51/54	48/51/54	46/49/52
Sound power level	dB(A)	53	55	60	62	63	63	64
Airflow (LS/MS/HS)	m³/h	450/500/580	450/530/650	490/550/660	1300/1500/1700	1400/1600/1850	1400/1600/1850	1600/1800/2200
Dehumidification	l/h	1.2	1.5	2	2.5	3.8	3.8	4.5
Outline dimensions (WxHxD)	mm	570x270x570	570x270x570	570x270x570	840x245x840	840x245x840	840x245x840	840x287x840
Package dimensions (WxHxD)	mm	655x290x655	655x290x655	655x290x655	900x257x900	900x257x900	900x257x900	900x292x900
Net weight/Gross weight	kg	14.5/17.3	18.6/19	16.5/19	24/28	26.4/30.4	26.4/30.4	28/32.1
Part number		7SP042259X	7SP042260	7SP042248	7SP042249	7SP042250	7SP042250	7SP042251
FRAME								
Outline dimensions (WxHxD)	mm	647x50x647	647x50x647	647x50x647	950x55x950	950x55x950	950x55x950	950x55x950
Package dimensions (WxHxD)	mm	715x123x715	715x123x715	715x123x715	1035x90x1035	1035x90x1035	1035x90x1035	1035x90x1035
Net weight/Gross weight	kg	2.5/4.5	2.5/4.5	2.5/4.5	5/8	5/8	5/8	5/8
Frame part number		7ACVF0566	7ACVF0566	7ACVF0566	7ACVF0564	7ACVF0564	7ACVF0564	7ACVF0564
OUTDOOR UNIT								
Sound pressure level to 1 m	dB(A)		56	54	60	61	61	63
Sound power level	dB(A)		63	65	65	67	68	72
Airflow	m³/h		2000	2100	2700	4300	4300	6800
Compressor type			Rotary DCI	Rotary DCI	Twin Rotary DCI	Twin Rotary DCI	Twin Rotary DCI	Twin Rotary DCI
Outline dimensions (WxHxD)	mm		800x554x333	800x554x333	845x363x702	946x410x810	946x410x810	952x415x1333
Package dimensions (WxHxD)	mm		920x615x390	920x615x390	965x396x765	1090x500x865	1090x500x865	1095x500x1470
Net weight/Gross weight	kg		29.9/32.6	35.5/38.4	49/51.5	67.2/72.9	78.9/83.9	108.1/121.2
Part number			7SP062970	7SP062892	7SP062893	7SP062895	7SP062896	7SP062899
POWER SUPPLY								
Phase/Tension/Frequency		1P/230V/50Hz	1P/230V/50Hz	1P/230V/50Hz	1P/230V/50Hz	1P/230V/50Hz	3P/400V/50Hz	3P/400V/50Hz
Power supply side			Outdoor	Ind. & Out.	Ind. & Out.	Ind. & Out.	Ind. & Out.	Ind. & Out.
Power cable section	mm²		3x1.5	3x1.0+3x2.5	3x1.0+3x2.5	3x1.0+3x4.0	3x1.0+5x2.5	3x1.0+5x2.5
Fuse rating am (D curve)	A		16	10+16	10+25	10+30	10+20	10+25
Electrical connections	mm²	4x1.0	4x1.0	2x0.5	2x0.5	2x0.5	2x0.5	2x0.5
PIPE LINE								
Suction pipe diameter	inches	3/8"	3/8"	1/2"	5/8"	5/8"	5/8"	5/8"
Liquid pipe diameter	inches	1/4"	1/4"	1/4"	3/8"	3/8"	3/8"	3/8"
Max. length	m		25	30	50	65	65	65
Max. height	m		10	20	25	30	30	30
Refrigerant / GWP			R410A/2088	R410A/2088	R410A/2088	R410A/2088	R410A/2088	R410A/2088
Charge (5 m)	kg		1.05	1.78	1.95	3.2	3.2	4
Additional charge	g/m		15	15	30	30	30	30

COMBINATIONS

Indoor unit Cassette	Compatible with outdoor unit	
	Monosplit	Multisplit
CCD 9X & CBD 18X 		YCZ 
CCD 12 	YMD 	YCZ 

Indoor unit Cassette	Compatible with outdoor unit	
	Monosplit	
CCD 18-24-36 	YMD 18-24-36 	
CCD 48 	YMD 48 	

Floor Ceiling range



MODEL NAME	Fluid type	Page	kBTU/h kW	12 3.5	18 5	24 7	36 10	48 12.5	60 16
UPGRADE									
	XBD	R410A	48	●					
CONSOLE DUAL FLOW MONOSPLIT & MULTISPLIT Ideal solution for replacement of electric heaters									
	FCD	R410A	50		●	●	●	●	●
FLOOR CEILING MONOSPLIT Large scope air									
			52						
SOLUTION DE REDONDANCE									
UPGRADE									
	FWDB	R410A	54		●	●			
FLOOR CEILING MONOSPLIT Dedicated design for low temperature rooms									

- **Low temperature local solution:** compliant with the CCTP of collective residential buildings
- Application for **wine cellars, garbage rooms, preparation rooms...**

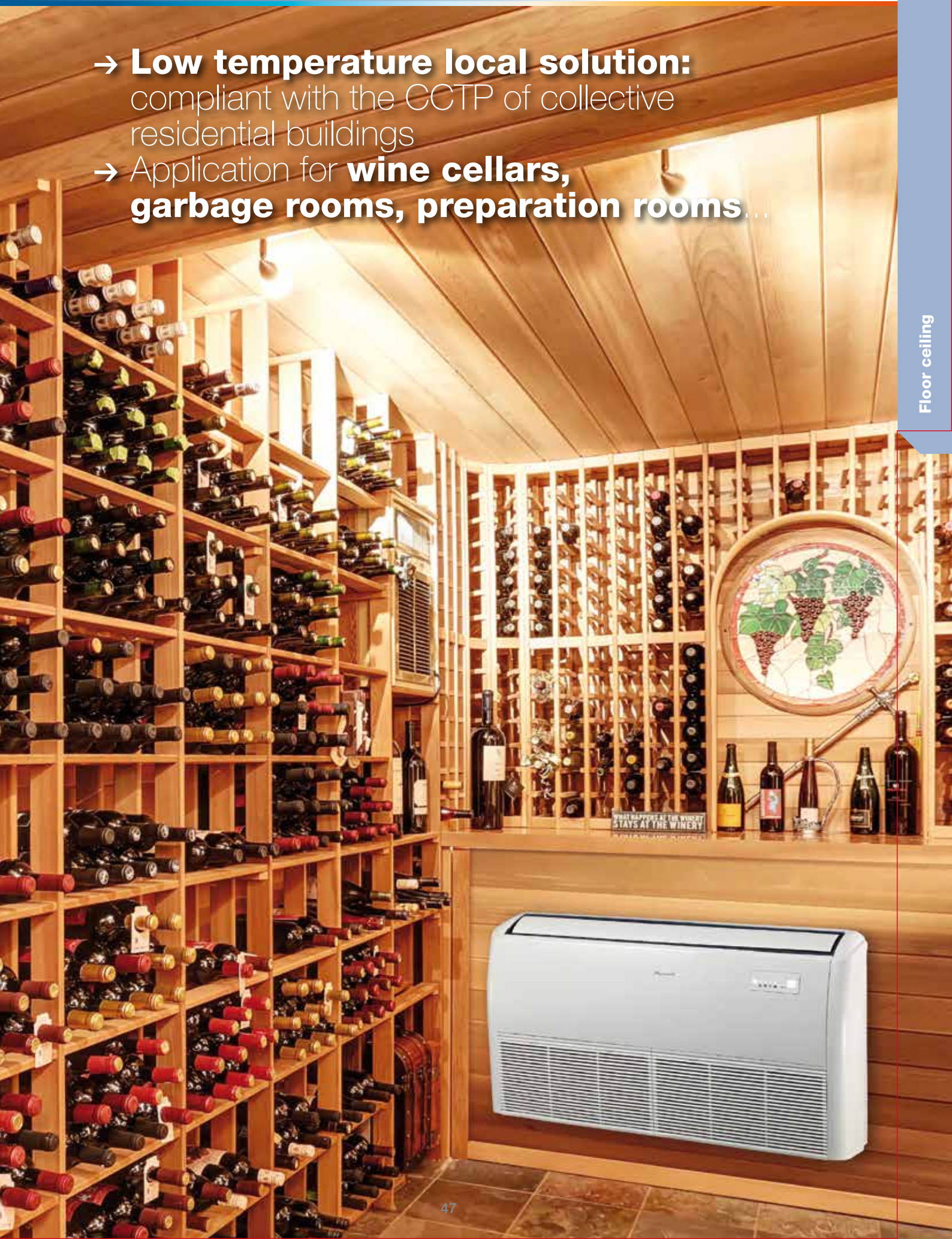



UPGRADE

A⁺⁺

+ PRODUCTS

- Compatible in monosplit and multisplit.
- Dual flow.
- G1 filter.



RC08C
included



RCW8
(optional)

FEATURES

TECHNOLOGY:



FLEXY MATCH



DC INVERTER



R410A FLUID



ELECTRONIC EXPANSION VALVE

AIR QUALITY / CLEAN:



ANTIBACTERIA FILTER

USER FUNCTIONS:



I FEEL



SLEEP MODE



PROGRAMMABLE TIMER



AUTO RESTART (MEMORY)



REMOTE CONTROL LOCK

INSTALLER FUNCTIONS:



DRY CONTACT ON/OFF



- Compact indoor unit for easy installation.
- Dual flow: control of the direction of the air flow for a better comfort.
- Reduced energy consumption using the hot mode alone.
- Interface dedicated to the installer for commissioning and maintenance.
- Inventory optimization thanks to a multi-range outdoor unit (YMD).

2 AIR OUTLET WAYS



OPTIONS



Accessory	Part number	Photo	Function
Wired single control RCW8	7ACEL1706		Mode, fan speed, timer ON/OFF, temperature and swing.



XBD TECHNICAL DATA

Indoor units		AWSI-XBD012-N11
Outdoor units		AWAU-YMD012-H11
Phase		Single phase
COOLING		
Rated power (min./max.)	kW	3.5 (0.8-3.8)
Pdesignc	kW	3.5
Rated power input	kW	1.21
SEER/Energy label		6.1/A++
Operating limits	°C	-20°/50° Dry bulb
HEATING		
Rated power (min./max.)	kW	3.8 (0.4-4.3)
Pdesignh (average climate)	kW	2.9
Pdesignh (warmer climate)	kW	3.4
Rated power input	kW	1.1
SCOP/Energy label (average climate)		4.0/A+
SCOP/Energy label (warmer climate)		5.1/A+++
Operating limits	°C	-20°/24° Dry bulb
INDOOR UNIT		
Sound pressure level to 1 m (LS/MS/HS)	dB(A)	35/41/43
Sound power level	dB(A)	58
Airflow (LS/MS/HS/SS)	m³/h	370/480/512
Dehumidification	l/h	1.5
Outline dimensions (WxHxD)	mm	700x600x210
Package dimensions (WxHxD)	mm	810x710x305
Net weight/Gross weight	kg	14.8/19
Part number		7SP071410
OUTDOOR UNIT		
Sound pressure level to 1 m	dB(A)	56
Sound power level	dB(A)	63
Airflow	m³/h	2000
Compressor type		Rotary
Outline dimensions (WxHxD)	mm	800x554x333
Package dimensions (WxHxD)	mm	920x615x390
Net weight/Gross weight	kg	29.9/32.6
Part number		7SP062970
POWER SUPPLY		
Phase/Tension/Frequency		1P/230V/50Hz
Power supply side		Outdoor
Power cable section	mm²	3x1.5
Fuse rating am (D curve)	A	16
Electrical connections	mm²	4x1.0
PIPE LINE		
Suction pipe diameter	inches	3/8"
Liquid pipe diameter	inches	1/4"
Max. length	m	25
Max. height	m	10
Refrigerant / GWP		R410A/2088
Charge	kg	1.05

COMBINATIONS

Indoor unit	Compatible with outdoor unit	
	Monosplit	Multisplit
Console XBD	YMD	YCZ
		



+ PRODUCTS

- Compatible in monosplit and multisplit.
- Wide air diffusion.
- Floor or ceiling installation.
- G1 filter.



RC08C
included



RCW6
(optional)



RCW8
(optional)

FEATURES

TECHNOLOGY:



DC INVERTER



R410A FLUID



ELECTRONIC EXPANSION VALVE



REDUNDANCY FUNCTION

AIR QUALITY / CLEAN:



ANTIBACTERIA FILTER



FRESH AIR

USER FUNCTIONS:



I FEEL



SLEEP MODE



PROGRAMMABLE TIMER



AUTO RESTART (MEMORY)



REMOTE CONTROL LOCK

INSTALLER FUNCTIONS:



DIGITAL DISPLAY



SELF DIAGNOSTIC



LEFT/RIGHT DRAIN CONNECTION



ALARM OUTPUT



UNIT ON INPUT



DRY CONTACT ON/OFF



WATER PUMP CONNECTION (OPTIONAL)



BMS COMPATIBLE



- Comfort "I Feel": temperature sensor in RC08C remote control.
- Reduced energy consumption using the hot mode alone.
- Interface dedicated to the installer for commissioning and maintenance.
- Compatible with a centralized remote control.
- Inventory optimization thanks to a multi-range outdoor unit (YMD).

4 DIMENSIONAL AIRFLOWS FOR MAXIMUM COMFORT

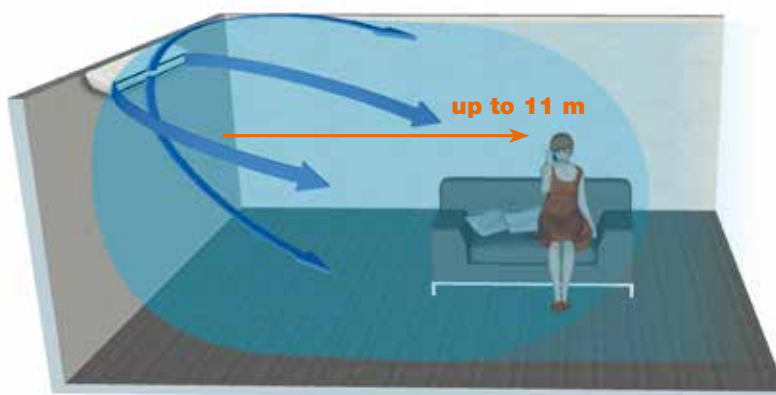

OPTIONS

Accessory	Part number	Photo	Function
Wired single control RCW6	7ACEL1704		Mode, fan speed, real time, timer, temperature, weekly timer and swing.
Wired single control RCW8	7ACEL1706		Mode, fan speed, timer ON/OFF, temperature and swing.
Central controller RCW16	7ACEL1707		Controls up to 64 indoor units with individual setting failure codes indication, ON-OFF dry contact, last operation memory, Modbus.
BMS gateway	7ACEL1708		Maximum 1024 units could be connected (16 gateways).



All sizes except FCD 048-060

FCD TECHNICAL DATA

Indoor units		AWSI-FCD018-N11	AWSI-FCD024-N11	AWSI-FCD036-N11	AWSI-FCD036-N11	AWSI-FCD048-N11	AWSI-FCD060-N11
Outdoor units		AWAU-YMD018-H11	AWAU-YMD024-H11	AWAU-YMD036-H11	AWAU-YMD036-H13	AWAU-YMD048-H13	AWAU-YMD060-H13
Phase		Single phase	Single phase	Single phase	Three phases	Three phases	Three phases
COOLING							
Rated power (min./max.)	kW	5.1 (0.8-6.1)	6.8 (1.2-8.2)	10.5 (2.9-12.0)	10.5 (2.9-12.0)	14.0 (4.0-16.4)	16.0 (5.0-18.1)
Pdesignc	kW	5.1	6.8	10.5	10.5	14.0	16.0
Rated power input	kW	1.579	2.252	4.008	4.008	5.344	6.107
SEER/Energy label		6.5/A++	6.1/A++	6.3/A++	6.1/A++	6.1/A++	6.1/A++
Operating limits	°C	-15°/50° Dry bulb					
HEATING							
Rated power (min./max.)	kW	5.6 (0.9-7.0)	7.5 (1.2-8.6)	11.0 (2.6-13.2)	11.0 (2.6-13.2)	16.0 (4.4-18.4)	18.0 (5.3-20.5)
Pdesignh (average climate)	kW	4.8	5.8	10.2	10.2	11.6	12
Pdesignh (warmer climate)	kW	5.2	5.8	10.5	10.5	11.6	12.2
Rated power input	kW	1.466	2.072	3.039	3.039	4.969	5.96
SCOP/Energy label (average climate)		4.0/A+	4.0/A+	4.0/A+	4.0/A+	4.0/A+	4.0/A+
SCOP/Energy label (warmer climate)		5.1/A+++	5.1/A+++	5.1/A+++	5.1/A+++	5.1/A+++	5.1/A+++
Operating limits	°C	-15°/24° Dry bulb					
INDOOR UNIT							
Sound pressure level to 1 m (LS/MS/HS)	dB(A)	38/41/44	44/49/52	43/49/52	43/49/52	46/51/54	46/51/57
Sound power level	dB(A)	57	63	63	63	66	69
Airflow (LS/MS/HS)	m³/h	700/800/900	850/1050/1180	1400/1770/2050	1400/1770/2050	1400/1800/2100	1280/1660/2250
Dehumidification	l/h	1.5	2.2	3.1	3.1	5	5.5
Outline dimensions (WxHxD)	mm	1068x675x235	1068x675x235	1650x675x235	1650x675x235	1650x675x235	1650x675x235
Package dimensions (WxHxD)	mm	1145x755x313	1145x755x313	1725x755x313	1725x755x313	1725x755x313	1725x755x313
Net weight/Gross weight	kg	25.8/30.6	25/30	40.3/46.9	40.3/46.9	38.2/44.6	40.5/47
Part number		7SP012231	7SP012232	7SP012233	7SP012233	7SP012234	7SP012235
OUTDOOR UNIT							
Sound pressure level to 1 m	dB(A)	54	60	61	61	63	63
Sound power level	dB(A)	65	65	67	68	72	75
Airflow	m³/h	2100	2700	4300	4300	6800	7200
Compressor type		Rotary DCI	Twin Rotary DCI	Twin Rotary DCI	Twin Rotary DCI	Twin Rotary DCI	Twin Rotary DCI
Outline dimensions (WxHxD)	mm	800x554x333	845x702x363	946x810x410	946x810x410	952x1333x415	952x1333x415
Package dimensions (WxHxD)	mm	920x615x390	965x765x396	1090x865x500	1090x865x500	1095x1470x500	1095x1470x500
Net weight/Gross weight	kg	35.5/38.4	49/51.5	67.2/72.9	78.9/83.9	108.1/121.2	112.8/126
Part number		7SP062892	7SP062893	7SP062895	7SP062896	7SP062899	7SP062900
POWER SUPPLY							
Phase/Tension/Frequency		1P/230V/50Hz	1P/230V/50Hz	1P/230V/50Hz	3P/400V/50Hz	3P/400V/50Hz	3P/400V/50Hz
Power supply side		Indoor & Outdoor	Indoor & Outdoor	Indoor & Outdoor	Indoor & Outdoor	Indoor & Outdoor	Indoor & Outdoor
Power cable section	mm²	3x1.0+3x2.5	3x1.0+3x2.5	3x1.0+3x4.0	3x1.0+5x2.5	3x1.0+5x2.5	3x1.0+5x2.5
Fuse rating am (D curve)	A	10+16	10+25	10+30	10+20	10+25	10+25
Electrical connections	mm²	2x0.5	2x0.5	2x0.5	2x0.5	2x0.5	2x0.5
PIPE LINE							
Suction pipe diameter	inches	1/2"	5/8"	5/8"	5/8"	5/8"	5/8"
Liquid pipe diameter	inches	1/4"	3/8"	3/8"	3/8"	3/8"	3/8"
Max. length	m	30	50	65	65	65	65
Max. height	m	20	25	30	30	30	30
Refrigerant / GWP		R410A/2088	R410A/2088	R410A/2088	R410A/2088	R410A/2088	R410A/2088
Charge (5 m)	kg	1,78	1,95	3,2	3,2	4	4,3
Charge additionnelle	g/m	15	30	30	30	30	30

COMBINATIONS

Indoor unit	Compatible with outdoor unit
Floor-ceiling FCD 18-24-36 	Monosplit YMD 18-24-36 
FCD 48-60 	YMD 48-60 



Unique
solutions

Redundancy function

Redundancy function



REDUNDANCY
FUNCTION

Airwell offers you a redundancy solution that makes it possible to secure a sensitive room by installing two jointly controlled air conditioners.

This solution is mainly used for computer rooms where the air conditioning system must operate continuously.

Main functions:

- Permutation of the operation of the air conditioner in case of failure of one of them.
- Fire safety: total shutdown of the air conditioning in case of fire.
- Simultaneous operation of both air conditioners installed, in case of high temperature.
- The inversion of the automatic order of the two units adjustable from 0 to 24 hours.
- Automatic restart in case of power failure.
- Management of operation hours of each system.
- Breakdowns rate management in real time.
- Filters clogging management.
- Faults report on a central display.
- Archiving of data on SD card.



COMPATIBLE
WITH

HIGH WALL HKD



DUCTED MEDIUM
STATIC PRESSURE DID





CASSETTE CCD



FLOOR-CEILING FCD



Accessory	Part number	Photo	Description
Central display	On demande Available from september 2018		Human Machine Interface Visualization of the system status (operating time, error codes, failure rate...)
Gateway	On demande		Control gateway to connect to indoor units TCP / IP port

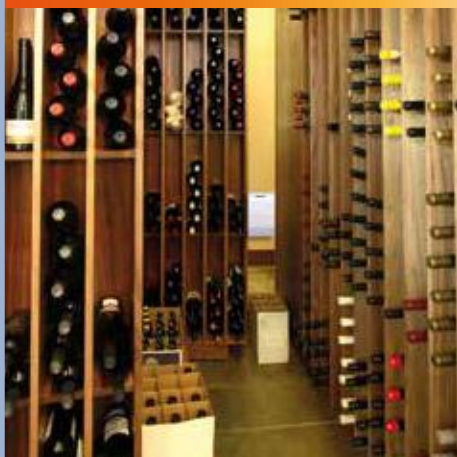

UPGRADE

+ PRODUCTS

- Application for wine cellar, garbage room, preparation rooms...
- Cooling and heating mode.
- G1 filter.



RCW6

FEATURES

TECHNOLOGY:



DC INVERTER



R410A FLUID



ELECTRONIC EXPANSION VALVE

AIR QUALITY / CLEAN:



ANTIBACTERIA FILTER



FRESH AIR

USER FUNCTIONS:



SLEEP MODE



PROGRAMMABLE TIMER



AUTO RESTART (MEMORY)



REMOTE CONTROL LOCK

INSTALLER FUNCTIONS:



DIGITAL DISPLAY



SELF DIAGNOSTIC



LEFT/RIGHT DRAIN CONNECTION



ALARM OUTPUT



UNIT ON INPUT



DRY CONTACT ON/OFF



WATER PUMP CONNECTION (OPTIONAL)



BMS COMPATIBLE



- Designed for local low temperature: 12°C minimum.
- Long blowing distance (up to 11 m).
- Guaranteed energy saving through weekly programming.



DEDICATED DESIGN FOR WINE CELLARS OR ANY LOW TEMPERATURE PROCESS ROOMS

OPTIONS

Accessory	Part number	Photo	Function
Central controller RCW16	7ACEL1707		Controls up to 64 indoor units with individual setting failure codes indication, ON-OFF dry contact, last operation memory, Modbus.
BMS gateway	7ACEL1708		Maximum 1024 units could be connected (16 gateways).



FWDB TECHNICAL DATA









Indoor units		AWSI-FWDB018-N11	AWSI-FWDB024-N11
Outdoor units		AWAU-YMDB018-H11	AWAU-YMDB024-H11
Phase		Single phase	Single phase
COOLING			
Rated power (min./max.)	kW	5.1 (0.8-6.1)	6.8 (1.2-8.2)
Pdesignc	kW	5.1	6.8
Rated power input	kW	1.579	2.252
SEER/Energy label		6.5/A++	6.1/A++
Operating limits	°C	-15°/50° Dry bulb	
HEATING			
Rated power (min./max.)	kW	5.6 (0.9-7.0)	7.5 (1.2-8.6)
Pdesignh (average climate)	kW	4.8	5.8
Pdesignh (warmer climate)	kW	5.2	5.8
Rated power input	kW	1.466	2.072
SCOP/Energy label (average climate)		4.0/A+	4.0/A+
SCOP/Energy label (warmer climate)		5.1/A+++	5.1/A+++
Operating limits	°C	-15°/24° Dry bulb	
INDOOR UNIT			
Sound pressure level to 1 m (LS/MS/HS)	dB(A)	38/41/44	44/49/52
Sound power level	dB(A)	57	63
Airflow (LS/MS/HS)	m³/h	700/800/900	850/1050/1180
Dehumidification	l/h	1.5	2.2
Outline dimensions (WxHxD)	mm	1068x235x675	1068x235x675
Package dimensions (WxHxD)	mm	1145x313x755	1145x313x755
Net weight/Gross weight	kg	25.8/30.6	25/30
Part number		7SP012246	7SP012247
OUTDOOR UNIT			
Sound pressure level to 1 m	dB(A)	54	60
Sound power level	dB(A)	65	65
Airflow	m³/h	2100	2700
Compressor type		Rotary DCI	Twin Rotary DCI
Outline dimensions (WxHxD)	mm	800x554x333	845x702x363
Package dimensions (WxHxD)	mm	920x615x390	965x765x396
Net weight/Gross weight	kg	35.5/38.4	49/51.5
Part number		7SP062924	7SP062925
POWER SUPPLY			
Phase/Tension/Frequency		1P/230V/50Hz	1P/230V/50Hz
Power supply side		Indoor & Outdoor	Indoor & Outdoor
Power cable section	mm²	3x1.0+3x2.5	3x1.0+3x2.5
Fuse rating am (D curve)	A	10+16	10+25
Electrical connections	mm²	2x0.5	2x0.5
PIPE LINE			
Suction pipe diameter	inches	1/2"	5/8"
Liquid pipe diameter	inches	1/4"	3/8"
Max. length	m	30	50
Max. height	m	20	25
Refrigerant / GWP		R410A/2088	R410A/2088
Charge	kg	1.78	1.95
Additional charge	g/m	15	30

COMBINATIONS

Indoor unit	Compatible with outdoor unit
Floor ceiling	Monosplit
FWDB	YMDB
	

Twin & Multisplit DCI Range

Combination Table

OUTDOOR UNITS		Fluid type	kW	Max. num. of indoors	Page			
TWIN APPLICATION Ducted and cassette	 <small>TWIN APPLICATION</small>		R410A	10-14	2	58		
			YDZA R32 refrigerant	YDZA2-18		R410A	5.3	2
YDZA R32 refrigerant	YDZA R32 refrigerant		R410A	7.8	3	60 & 64		
			YDZA3-27		R410A	8.5	4	60 & 65
			YDZA4-30		R410A	12.3	5	60 & 66
			YDZA2-18		R32	5.0	2	68 & 70
NEW YDZA R32 refrigerant	YDZA R32 refrigerant		R32	7.0	3	68 & 70		
			YDZA3-27		R32	8.5	4	68 & 71
YDZA R32 refrigerant	YDZA4-30		R32	8.5	4	68 & 71		



INDOOR UNITS

High wall HDM	High wall HKD	Ducted medium static pressure DID	Cassette CCD	Console XBD
				

18+18/24+24 18+18/24+24

Sizes 9/12/18 Size 12 Sizes 9X/12/18X Size 12

Sizes 9/12/18 Size 12 Sizes 9X/12/18X Size 12

Sizes 9/12/18/24 Size 12 Sizes 9X/12/18X Size 12

Sizes 9/12/18/24 Size 12 Sizes 9X/12/18X Size 12

Sizes 9/12/18/24

Sizes 9/12/18/24

Sizes 9/12/18/24



• Unique
solutions

Twin application



Twin application

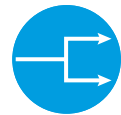

TWIN APPLICATION

The twin application is used mainly in big open space where the total space area is controlled by one controller only for 2 units. Airwell twin design allows to connect two similar indoor units to one common outdoor unit. The two indoor units are working in a same mode and set up only once, one indoor unit used as master.

The most cost saving solution for single-area spaces:

- Simple installation by having one refrigerant and control system.
- Space saving by using one outdoor unit instead of two.
- Low cost installation.
- Simple control, one control station for big space.
- Option to control by wireless or wired controller.
- Ducted or cassette application.

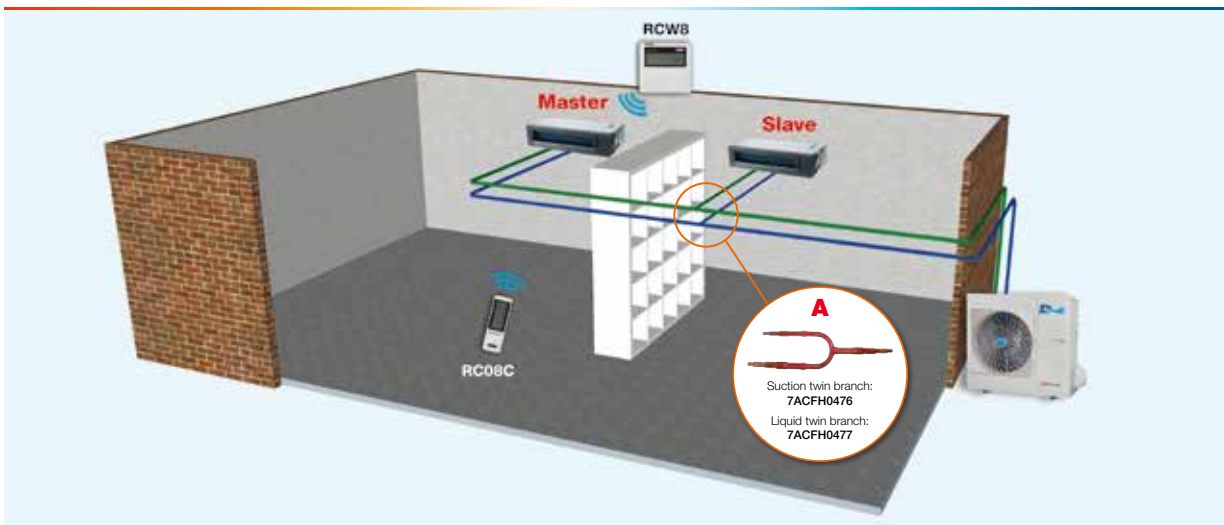

	Indoor units	Outdoor units
Twin system	CCD018 + CCD018	YMD036
	DID018 + DID018	
	CCD024 + CCD024	YMD048
	DID024 + DID024	

Tube & charge instructions	YMD036	YMD048
Pipe diameter (liquid-gas) (inches)	3/8"-5/8"	
Max. length (m)	30	50
Max. difference in branch length (m)	10	
Max. height drop between indoor units (m)	0.5	
Max. height drop between indoor and outdoor units (m)	20	
Max. branch length (m)	15	

TWIN APPLICATION WITH			Page
DID	Ducted medium static pressure monosplit		36
CCD	Cassette DC Inverter		42

DC Inverter
Cooling & heating

YCZ RESIDENTIAL MULTISPLIT DUO/TRIO/QUATTRO/CINCO



+ PRODUCTS

- Efficient.
- Competitive.
- Flexible.

FEATURES

TECHNOLOGY:



DC INVERTER



R410A FLUID



ELECTRONIC EXPANSION VALVE

INSTALLER FUNCTIONS:



SELF DIAGNOSTIC



YCZ2-18



YCZ3-27
YCZ4-30
YCZ5-42

- Match with high wall, ducted, cassette and console indoor units.
- Same indoor for multi and single application (see table).
- Design for long tubing distance installation.
- 2 digit display to check running parameters.

COMPATIBLE WITH

HIGH WALL
HKD 9/12/18/24

DUCTED MEDIUM STATIC
PRESSURE DID 12



CASSETTE
CCD 9X/12/18X

CONSOLE
XBD 12



COMBINATIONS

Sizes	High wall HKD	Ducted DID	Cassette CCD	Console XBD
9	AWSI-HKD009-N11 7SP023054	-	AWSI-CCD009X-N11 7SP042259X Frame part number 7ACVF0566	-
12	AWSI-HKD012-N11 7SP023055	AWSI-DID012-N11 7SP032190	AWSI-CCD012-N11 7SP042260 Frame part number 7ACVF0566	AWSI-XBD012-N11 7SP071410
18	AWSI-HKD018-N11 7SP023056	-	AWSI-CBD018X-N11 7SP042239X Frame part number 7ACVF0566	-
24	AWSI-HKD024-N11 7SP023057	-	-	-

* Dedicated part number for multisplit application.



Depending on combination

YCZ TECHNICAL DATA

Outdoor units			AWAU-YCZ218-H11	AWAU-YCZ327-H11	AWAU-YCZ430-H11	AWAU-YCZ542-H11
Phase			Single phase	Single phase	Single phase	Single phase
OUTDOOR UNIT						
Cooling	Rated power (min./max.)	kW	5.3 (1.8-6.3)	7.8 (2.7-8.7)	8.5 (2.8-9.2)	12.3 (3.0-13.5)
	Pdesignc	kW	5.3	7.8	8.5	12.3
	Rated power input	kW	1.419	2.422	2.64	3.82
	SEER/Energy label		7.4/A++ *	6.6/A++ *	6.6/A++ *	6.6/A++ *
	Operating limits	°C	-15°/50° Dry bulb			
Heating	Rated power (min./max.)	kW	6.0 (2.0-6.5)	8.5 (2.8-9.2)	9.0 (2.8-10.0)	12.3 (3.0-14.0)
	Pdesignh (average climate)	kW	5.3	6.5	7.2	9.6
	Pdesignh (warmer climate)	kW	5.5	6.6	7.3	9.8
	Rated power input	kW	1.657	2.348	2.486	3.407
	SCOP/Energy label (average climate)		4.1/A+	4.0/A	3.9/A	3.8/A
	SCOP/Energy label (warmer climate)		5.1/A+++	5.1/A+++	5.1/A+++	4.6/A++
	Operating limits	°C	-15°/24° Dry bulb			
	Power @ -10°C	kW	4.5	6.5	6.6	8.4
Power @ -15°C	kW	4.0	5.7	5.8	7.2	
Sound pressure level to 1 m	dB(A)	55	58	58	60	
Sound power level	dB(A)	63	67	67	70	
Airflow	m³/h	2500	3500	3500	5500	
Compressor type		Twin Rotary DC Inverter	Twin Rotary DC Inverter	Twin Rotary DC Inverter	Twin Rotary DC Inverter	
Outline dimensions (WxHxD)	mm	923x702x363	1034x810x410	1034x810x410	1034x810x410	
Package dimensions (WxHxD)	mm	965x755x395	1090x865x500	1090x865x500	1090x865x500	
Net weight/Gross weight	kg	48/52	68/73	70/75	76/81	
Part number		7SP091170	7SP091171	7SP091172	7SP091173	
POWER SUPPLY						
Phase/Tension/Frequency		1P/230V/50Hz	1P/230V/50Hz	1P/230V/50Hz	1P/230V/50Hz	
Power supply side		Outdoor	Outdoor	Outdoor	Outdoor	
Power cable section	mm²	3x2.5	3x2.5	3x2.5	3x4.0	
Fuse rating am (D curve)	A	25	25	25	32	
Electrical connections	mm²	2 (4x1.0)	3 (4x1.0)	4 (4x1.0)	5 (4x1.0)	
PIPE LINE						
Suction pipe diameter	inches	2x3/8"	3x3/8"	4x3/8"	4x3/8"+1/2"	
Liquid pipe diameter	inches	2x1/4"	3x1/4"	4x1/4"	5x1/4"	
Max. length	m	30	45	60	80	
Max. length per circuit	m	20	25	30	30	
Max. height between indoor and outdoor units	ODU higher than IDU	m	10	10	10	10
	ODU lower than IDU	m	15	15	15	15
Max. height between indoor units	m	10	10	10	10	
Refrigerant / GWP		R410A/2088	R410A/2088	R410A/2088	R410A/2088	
Charge / Amount length	kg/m	2 / 15	2.4 / 22.5	2.4 / 30	3.6 / 37.5	

* A++ for HKD 9 x 3 combinations.

Nota: Pipe adaptor (3/8" → 1/2") needs to be fixed on the gas valve of outdoor unit when connecting 18K indoor unit. This adaptor can be supplied by Airwell (ref. 15111600000297).

Pipe adaptor 3/8" → 5/8" needs to be fixed on the gas valve and a pipe adaptor 1/4" → 3/8" on the liquid valve of outdoor unit when connecting 24K indoor unit.

HIGH WALL
HKD 9/12/18/24



HKD INDOOR UNITS TECHNICAL DATA

Indoor units		AWSI-HKD009-N11	AWSI-HKD012-N11	AWSI-HKD018-N11	AWSI-HKD024-N11
Phase		Single phase	Single phase	Single phase	Single phase
Rated power (min./max.)	kW	2.65 (1.0 -3.2)	3.54(1.08-4.1)	5.0(1.8-6.1)	6.8(2.7-7.8)
Rated power (min./max.)	kW	2.7 (0.82-3.3)	3.2 (0.9-4.2)	5.0 (1.4-6.7)	7.3 (1.6-8.7)
Sound pressure level to 1 m (VL/LS/MS/HS)	dB(A)	23/29/34/38	24/33/37/42	24/32/36/42	32/35/40/44
Sound power level	dB(A)	54	54	57	60
Airflow (VL/LS/MS/HS)	m³/h	270/320/420	370/470/570	540/680/840	640/800/980
Dehumidification	l/h	1.0	1.2	1.7	2.4
Outline dimensions (WxHxD)	mm	715x285x194	805x285x194	957x302x213	1040x327x220
Package dimensions (WxHxD)	mm	780x360x270	870x360x270	1035x380x295	1120x310x405
Net weight/Gross weight	kg	6.8/8.9	7.2/9.6	9.5/12.5	11.9/15.2
PIPE LINE					
Suction pipe diameter	inches	3/8"	3/8"	1/2"	5/8"
Liquid pipe diameter	inches	1/4"	1/4"	1/4"	3/8"
Part number		7SP023054	7SP023055	7SP023056	7SP023057

DUCTED MEDIUM STATIC
PRESSURE DID 12



CASSETTE
CCD 9X/12/18X



DID & CCD INDOOR UNITS TECHNICAL DATA

Indoor unit		AWSI-DID012-N11	AWSI-CCD009X-N11	AWSI-CCD012-N11	AWSI-CBD018X-N11
Phase		Single phase	Single phase	Single phase	Single phase
Cooling rated power (min./max.)	kW	3.5 (0.5-4.1)	2.6 (0.8-3.3)	3.5 (0.8-4.1)	5.1 (0.8-6.1)
Heating rated power (min./max.)	kW	3.80 (0.9-4.6)	2.9 (0.85-3.7)	4.1 (0.5-4.4)	5.6 (0.9-7.0)
Sound pressure level to 1 m (LS/MS/HS)	dB(A)	27/34/40	32/36/39	35/39/43	36/40/44
Sound power level	dB(A)	60	53	57	60
Airflow (LS/MS/HS)	m³/h	300/480/600	450/500/580	416/504/617	490/550/660
External static pressure	Pa	25 (0-60)			
Dehumidification	l/h	1.5	1.2	1.5	2
Outline dimensions (WxHxD)	mm	700x200x450	570x270x570	570x260x570	570x270x570
Package dimensions (WxHxD)	mm	860x275x540	655x290x655	655x290x655	655x290x655
Net weight/Gross weight	kg	18/22	14.5/17.3	16.2/21.4	16.5/19
FRAME					
Outline dimensions (WxHxD)	mm		647x50x647	950x55x950	647x50x647
Package dimensions (WxHxD)	mm		715x123x715	1035x90x1035	715x123x715
Net weight/Gross weight	kg		2.5/4.5	5/8	2.5/4.5
Frame part number			7ACVF0566	7ACVF0566	7ACVF0566
PIPE LINE					
Suction pipe diameter	inches	3/8"	3/8"	3/8"	1/2"
Liquid pipe diameter	inches	1/4"	1/4"	1/4"	1/4"
Part number		7SP032190	7SP042259X	7SP042260	7SP042239X

CONSOLE
XBD 12



XBD INDOOR UNITS TECHNICAL DATA

Indoor units		AWSI-XBD012-N11
Phase		Single phase
Cooling rated power (min./max.)	kW	3.5 (0.8-3.8)
Heating rated power (min./max.)	kW	3.8 (0.4-4.3)
Sound pressure level to 1 m (LS/MS/HS)	dB(A)	35/41/43
Sound power level	dB(A)	58
Airflow (LS/MS/HS/SS)	m ³ /h	370/480/512
Dehumidification	l/h	1.5
Outline dimensions (WxHxD)	mm	700x600x210
Package dimensions (WxHxD)	mm	810x710x305
Net weight/Gross weight	kg	14.8/19
PIPE LINE		
Suction pipe diameter	inches	3/8"
Liquid pipe diameter	inches	1/4"
Part number		7SP071410

COMPATIBLE WITH

HIGH WALL
HKD 9/12/18/24



DUCTED MEDIUM STATIC
PRESSURE DID 12



CASSETTE
CCD 9X/12/18X



CONSOLE
XBD 12



YCZ2-18 RESIDENTIAL MULTISPLIT DUO

Indoor units combinations	COOLING									HEATING								
	Rated power (kW)		Total power (kW)			Total input power (kW)			EER/ Energy label	Rated power (kW)		Total power (kW)			Total input power (kW)			COP/ Energy label
	Unit A	Unit B	Rated	Min.	Max.	Rated	Min.	Max.		Unit A	Unit B	Rated	Min.	Max.	Rated	Min.	Max.	
9+9	2.65	2.65	5.30	1.80	6.20	1.55	0.55	2.16	3.42/A	3.00	3.00	6.00	2.00	6.50	1.66	0.58	1.81	3.62/A
9+12	2.27	3.03	5.30	1.80	6.30	1.55	0.55	2.16	3.42/A	2.57	3.43	6.00	2.00	6.50	1.66	0.58	1.81	3.62/A
9+18	1.77	3.53	5.30	1.80	6.30	1.55	0.55	2.16	3.42/A	2.00	4.00	6.00	2.00	6.70	1.66	0.58	1.89	3.62/A
12+12	2.65	2.65	5.30	1.80	6.30	1.55	0.55	2.16	3.42/A	3.00	3.00	6.00	2.00	6.70	1.66	0.58	1.89	3.62/A

Based on wall mounted combination



YCZ3-27 RESIDENTIAL MULTISPLIT TRIO

Indoor units combinations	COOLING									HEATING										
	Rated power (kW)			Total power (kW)			Total input power (kW)			EER/ Energy label	Rated power (kW)			Total power (kW)			Total input power (kW)			COP/ Energy label
	Unit A	Unit B	Unit C	Rated	Min.	Max.	Rated	Min.	Max.		Unit A	Unit B	Unit C	Rated	Min.	Max.	Rated	Min.	Max.	
12+12	3.54	3.54	-	7.08	2.45	8.70	2.17	0.69	2.90	3.26/A	3.70	3.70	-	7.40	2.44	9.20	2.05	0.67	2.70	3.61/A
9+18	2.65	5.00	-	7.65	2.65	8.70	2.37	0.75	2.90	3.23/A	2.80	5.50	-	8.30	2.73	9.20	2.30	0.74	2.70	3.61/A
12+18	3.12	4.68	-	7.80	2.70	8.74	2.42	0.76	2.91	3.22/A	3.40	5.10	-	8.50	2.80	9.25	2.35	0.76	2.71	3.62/A
18+18	3.90	3.90	-	7.80	2.70	8.83	2.42	0.76	2.94	3.22/A	4.25	4.25	-	8.50	2.80	9.34	2.35	0.76	2.74	3.62/A
9+9+9	2.60	2.60	2.60	7.80	2.70	8.70	2.42	0.76	2.90	3.22/A	2.83	2.83	2.83	8.50	2.80	9.20	2.35	0.70	2.70	3.62/A
9+9+12	2.34	2.34	3.12	7.80	2.70	8.74	2.42	0.76	2.91	3.22/A	2.55	2.55	3.40	8.50	2.80	9.25	2.35	0.70	2.71	3.62/A
9+9+18	1.95	1.95	3.90	7.80	2.70	8.83	2.42	0.76	2.94	3.22/A	2.13	2.13	4.24	8.50	2.80	9.34	2.35	0.70	2.74	3.62/A
9+12+12	2.12	2.84	2.84	7.80	2.70	8.79	2.42	0.76	2.93	3.22/A	2.32	3.09	3.09	8.50	2.80	9.29	2.35	0.70	2.73	3.62/A
9+12+18	1.80	2.40	3.60	7.80	2.70	8.87	2.42	0.76	2.96	3.22/A	1.96	2.62	3.92	8.50	2.80	9.38	2.35	0.70	2.75	3.62/A
12+12+12	2.60	2.60	2.60	7.80	2.70	8.83	2.42	0.76	2.94	3.22/A	2.83	2.83	2.83	8.50	2.80	9.34	2.35	0.70	2.74	3.62/A

Based on wall mounted combination



YCZ4-30 RESIDENTIAL MULTISPLIT QUATTRO

Indoor units combinations	COOLING											HEATING										
	Rated power (kW)				Total power (kW)			Total input power (kW)			EER/ Energy label	Rated power (kW)				Total power (kW)			Total input power (kW)			COP/ Energy label
	Unit A	Unit B	Unit C	Unit D	Rated	Min.	Max.	Rated	Min.	Max.		Unit A	Unit B	Unit C	Unit D	Rated	Min.	Max.	Rated	Min.	Max.	
12+12	3.54	3.54	-	-	7.08	2.25	7.60	2.12	0.64	2.58	3.34/A	3.70	3.70	-	-	7.40	2.30	9.60	2.14	0.72	2.93	3.46/B
9+18	2.65	5.00	-	-	7.65	2.43	9.40	2.33	0.69	3.20	3.28/A	2.80	5.50	-	-	8.30	2.58	10.00	2.40	0.79	3.05	3.46/B
9+24	2.32	6.18	-	-	8.50	2.70	9.80	2.64	0.77	3.40	3.22/A	2.45	6.55	-	-	9.00	2.86	10.00	2.61	0.94	3.19	3.45/B
12+18	3.40	5.10	-	-	8.50	2.70	9.40	2.64	0.77	3.40	3.22/A	3.40	5.10	-	-	8.50	2.64	10.00	2.46	0.81	3.05	3.46/B
12+24	2.83	5.67	-	-	8.50	2.70	9.80	2.64	0.77	3.40	3.22/A	3.00	6.00	-	-	9.00	2.86	10.00	2.61	0.94	3.19	3.45/B
18+18	4.25	4.25	-	-	8.50	2.70	9.80	2.64	0.77	3.40	3.22/A	4.50	4.50	-	-	9.00	2.80	10.00	2.61	0.85	3.05	3.45/B
9+9+9	2.65	2.65	2.65	-	7.95	2.53	9.50	2.44	0.72	3.00	3.26/A	2.83	2.83	2.83	-	8.50	2.64	10.00	2.40	0.75	3.05	3.54/B
9+9+12	2.55	2.55	3.40	-	8.50	2.70	9.80	2.64	0.77	3.13	3.22/A	2.70	2.70	3.60	-	9.00	2.80	10.00	2.55	0.79	3.05	3.53/B
9+9+18	2.13	2.13	4.24	-	8.50	2.70	9.80	2.64	0.77	3.13	3.22/A	2.25	2.25	4.50	-	9.00	2.80	10.00	2.55	0.79	3.05	3.53/B
9+12+12	2.32	3.09	3.09	-	8.50	2.70	9.80	2.64	0.77	3.13	3.22/A	2.46	3.27	3.27	-	9.00	2.80	10.00	2.55	0.79	3.05	3.53/B
9+12+18	1.96	2.62	3.92	-	8.50	2.70	9.92	2.64	0.77	3.17	3.22/A	2.08	2.77	4.15	-	9.00	2.80	10.12	2.55	0.79	3.09	3.53/B
12+12+12	2.83	2.83	2.83	-	8.50	2.70	9.80	2.64	0.77	3.13	3.22/A	3.00	3.00	3.00	-	9.00	2.80	10.00	2.55	0.79	3.05	3.53/B
12+12+18	2.43	2.43	3.64	-	8.50	2.70	10.04	2.64	0.77	3.21	3.22/A	2.57	2.57	3.86	-	9.00	2.80	10.24	2.55	0.79	3.12	3.53/B
9+9+9+9	2.13	2.13	2.13	2.13	8.50	2.70	9.80	2.64	0.77	3.13	3.22/A	2.25	2.25	2.25	2.25	9.00	2.80	10.00	2.49	0.73	3.05	3.61/A
9+9+9+12	1.96	1.96	1.96	2.62	8.50	2.70	9.92	2.64	0.77	3.17	3.22/A	2.08	2.08	2.08	2.76	9.00	2.80	10.12	2.49	0.73	3.09	3.61/A

Based on wall mounted combination

COMPATIBLE WITH

HIGH WALL
HKD 9/12/18/24



DUCTED MEDIUM STATIC
PRESSURE DID 12



CASSETTE
CCD 9X/12/18X



CONSOLE
XBD 12



YCZ5-42 RESIDENTIAL MULTISPLIT CINCO

Indoor units combinations	COOLING												HEATING											
	Rated power (kW)					Total cooling power (kW)			Total Input power (kW)			EER/ Energy label	Rated power (kW)					Total heating power (kW)			Total Input power (kW)			COP/ Energy label
	Unit A	Unit B	Unit C	Unit D	Unit E	Rated	Min.	Max.	Rated	Min.	Max.		Unit A	Unit B	Unit C	Unit D	Unit E	Rated	Min.	Max.	Rated	Min.	Max.	
18+18	5.00	5.00	-	-	-	10.00	2.44	12.20	2.94	0.67	3.43	3.40/A	5.50	5.50	-	-	-	11.00	2.69	12.20	3.13	0.81	3.49	3.51/B
18+24	5.00	6.80	-	-	-	11.80	2.88	13.50	3.62	0.79	3.80	3.26/A	5.27	7.03	-	-	-	12.30	3.07	13.50	3.52	0.91	3.86	3.49/B
9+9+18	2.65	2.65	5.00	-	-	10.30	2.51	12.38	3.05	0.69	3.48	3.38/A	2.80	2.80	5.50	-	-	11.10	2.89	12.38	3.12	0.82	3.54	3.56/B
9+9+24	2.65	2.65	6.80	-	-	12.10	2.95	13.50	3.74	0.81	3.80	3.24/A	2.64	2.64	7.02	-	-	12.30	3.15	13.50	3.48	0.89	3.86	3.53/B
9+12+12	2.65	3.54	3.54	-	-	9.73	2.37	11.80	2.84	0.65	3.32	3.43/A	2.80	3.70	3.70	-	-	10.20	2.65	11.80	2.86	0.76	3.37	3.57/B
9+12+18	2.65	3.54	5.00	-	-	11.19	2.73	13.50	3.38	0.75	3.80	3.31/A	2.80	3.70	5.50	-	-	12.00	3.12	13.60	3.39	0.88	3.89	3.54/B
9+12+24	2.46	3.28	6.56	-	-	12.30	3.00	13.50	3.82	0.82	3.80	3.22/A	2.46	3.28	6.56	-	-	12.30	3.20	13.50	3.48	0.90	3.86	3.53/B
9+18+18	2.46	4.92	4.92	-	-	12.30	3.00	13.50	3.82	0.82	3.80	3.22/A	2.46	4.92	4.92	-	-	12.30	3.20	14.06	3.48	0.90	4.02	3.53/B
12+12+12	3.54	3.54	3.54	-	-	10.62	2.59	13.00	3.17	0.71	3.66	3.35/A	3.70	3.70	3.70	-	-	11.10	2.89	13.00	3.12	0.82	3.71	3.56/B
12+12+18	3.54	3.54	5.00	-	-	12.08	2.95	13.50	3.73	0.81	3.80	3.24/A	3.51	3.51	5.28	-	-	12.30	3.20	14.00	3.48	0.90	4.00	3.53/B
12+12+24	3.08	3.08	6.14	-	-	12.30	3.00	13.50	3.82	0.82	3.80	3.22/A	3.08	3.08	6.14	-	-	12.30	3.20	13.50	3.48	0.90	3.86	3.53/B
12+18+18	3.08	4.61	4.61	-	-	12.30	3.00	13.50	3.82	0.82	3.80	3.22/A	3.08	4.61	4.61	-	-	12.30	3.20	14.11	3.48	0.90	4.03	3.53/B
12+18+24	2.73	4.10	5.47	-	-	12.30	3.00	13.50	3.82	0.82	3.80	3.22/A	2.73	4.10	5.47	-	-	12.30	3.20	13.50	3.48	0.90	3.86	3.53/B
18+18+18	4.10	4.10	4.10	-	-	12.30	3.00	13.50	3.82	0.82	3.80	3.22/A	4.10	4.10	4.10	-	-	12.30	3.20	14.22	3.48	0.90	4.06	3.53/B
9+9+9+9	2.65	2.65	2.65	2.65	-	10.60	2.59	13.50	3.16	0.71	3.80	3.35/A	2.80	2.80	2.80	2.80	-	11.20	2.91	14.00	3.11	0.79	4.00	3.60/B
9+9+9+12	2.65	2.65	2.65	3.54	-	11.49	2.80	13.50	3.50	0.77	3.80	3.28/A	2.80	2.80	2.80	3.70	-	12.10	3.15	14.00	3.38	0.85	4.00	3.58/B
9+9+9+18	2.46	2.46	2.46	4.92	-	12.30	3.00	13.50	3.82	0.82	3.80	3.22/A	2.46	2.46	2.46	4.92	-	12.30	3.20	14.06	3.44	0.86	4.02	3.58/B
9+9+9+24	2.17	2.17	2.17	5.79	-	12.30	3.00	13.64	3.82	0.82	3.84	3.22/A	2.17	2.17	2.17	5.79	-	12.30	3.20	13.64	3.44	0.86	3.90	3.58/B
9+9+12+12	2.64	2.64	3.51	3.51	-	12.30	3.00	13.50	3.82	0.82	3.80	3.22/A	2.64	2.64	3.51	3.51	-	12.30	3.20	14.00	3.44	0.86	4.00	3.58/B
9+9+12+18	2.31	2.31	3.08	4.60	-	12.30	3.00	13.57	3.82	0.82	3.82	3.22/A	2.31	2.31	3.08	4.60	-	12.30	3.20	14.11	3.44	0.86	4.03	3.58/B
9+9+12+24	2.05	2.05	2.73	5.47	-	12.30	3.00	13.70	3.82	0.82	3.86	3.22/A	2.05	2.05	2.73	5.47	-	12.30	3.20	13.70	3.44	0.86	3.91	3.58/B
9+9+18+18	2.05	2.05	4.10	4.10	-	12.30	3.00	13.70	3.82	0.82	3.86	3.22/A	2.05	2.05	4.10	4.10	-	12.30	3.20	14.22	3.44	0.86	4.06	3.58/B
9+12+12+12	2.46	3.28	3.28	3.28	-	12.30	3.00	13.50	3.82	0.82	3.80	3.22/A	2.46	3.28	3.28	3.28	-	12.30	3.20	14.06	3.44	0.86	4.02	3.58/B
9+12+12+18	2.17	2.89	2.89	4.35	-	12.30	3.00	13.64	3.82	0.82	3.84	3.22/A	2.17	2.89	2.89	4.35	-	12.30	3.20	14.17	3.44	0.86	4.05	3.58/B
9+12+12+24	1.94	2.59	2.59	5.18	-	12.30	3.00	13.77	3.82	0.82	3.88	3.22/A	1.94	2.59	2.59	5.18	-	12.30	3.20	13.77	3.44	0.86	3.93	3.58/B
9+12+18+18	1.94	2.60	3.88	3.88	-	12.30	3.00	13.77	3.82	0.82	3.88	3.22/A	1.94	2.59	3.89	3.89	-	12.30	3.20	13.77	3.44	0.86	3.93	3.58/B
12+12+12+12	3.08	3.08	3.08	3.08	-	12.30	3.00	13.57	3.82	0.82	3.82	3.22/A	3.08	3.08	3.08	3.08	-	12.30	3.20	14.11	3.44	0.86	4.03	3.58/B
12+12+12+18	2.73	2.73	2.73	4.11	-	12.30	3.00	13.70	3.82	0.82	3.86	3.22/A	2.73	2.73	2.73	4.11	-	12.30	3.20	14.22	3.44	0.86	4.06	3.58/B
9+9+9+9+9	2.46	2.46	2.46	2.46	2.46	12.30	3.00	13.50	3.82	0.82	3.80	3.22/A	2.46	2.46	2.46	2.46	2.46	12.30	3.20	14.06	3.40	0.82	4.02	3.62/A
9+9+9+9+12	2.31	2.31	2.31	2.31	3.08	12.30	3.00	13.57	3.82	0.82	3.82	3.22/A	2.31	2.31	2.31	2.31	3.08	12.30	3.20	14.11	3.40	0.82	4.03	3.62/A
9+9+9+9+18	2.05	2.05	2.05	2.05	4.10	12.30	3.00	13.70	3.82	0.82	3.86	3.22/A	2.05	2.05	2.05	2.05	4.10	12.30	3.20	14.22	3.40	0.82	4.06	3.62/A
9+9+9+12+12	2.17	2.17	2.17	2.90	2.90	12.30	3.00	13.64	3.82	0.82	3.84	3.22/A	2.17	2.17	2.17	2.90	2.90	12.30	3.20	14.17	3.40	0.82	4.05	3.62/A
9+9+9+12+18	1.94	1.94	1.94	2.59	3.89	12.30	3.00	13.77	3.82	0.82	3.88	3.22/A	1.94	1.94	1.94	2.59	3.89	12.30	3.20	14.28	3.40	0.82	4.08	3.62/A
9+9+12+12+12	2.06	2.06	2.73	2.73	2.73	12.30	3.00	13.70	3.82	0.82	3.86	3.22/A	2.06	2.06	2.73	2.73	2.73	12.30	3.20	14.22	3.40	0.82	4.06	3.62/A
9+12+12+12+12	1.94	2.59	2.59	2.59	2.59	12.30	3.00	13.77	3.82	0.82	3.88	3.22/A	1.94	2.59	2.59	2.59	2.59	12.30	3.20	14.28	3.40	0.82	4.08	3.62/A

Based on wall mounted combination

Handwriting practice area consisting of 30 horizontal dotted lines.

DC Inverter
Cooling & heating

YDZA RESIDENTIAL MULTISPLIT DUO/TRIO/QUATTRO



NEW



+ PRODUCTS

- R32 refrigerant with low environmental impact.
- High efficiency.

FEATURES

TECHNOLOGY:



DC INVERTER



R32 FLUID

INSTALLER FUNCTIONS:



SELF DIAGNOSTIC



- Match with high wall indoor units.
- Design for long tubing distance installation.
- 2 digit display to check running parameters.

COMPATIBLE
WITH

HIGH WALL
HDM 9/12/18/24





YDZA TECHNICAL DATA

Outdoor units			AW-YDZA218-H91	AW-YDZA327-H91	AW-YDZA430-H91
Phase			Single phase	Single phase	Single phase
OUTDOOR UNIT					
Cooling	Rated power (min./max.)	kW	5.0 (1.3-6.0)	7.0 (2.4-8.4)	8.5 (3.2-9.5)
	Pdesignc	kW	5.0	7.0	8.5
	Rated power input	kW	1.56	1.66	2.23
	SEER/Energy label		6.5/A++	8.0/A++	7.5/A++
	Operating limits	°C	-10°/46° Dry bulb		
Heating	Rated power (min./max.)	kW	5.7 (1.8-6.6)	8.6 (2.9-10.6)	9.6 (4.4-10.7)
	Pdesignh (average climate)	kW	5.2	6.0	7.0
	Rated power input	kW	1.54	1.86	2.23
	SCOP/Energy label (average climate)		4.0/A+	4.0/A+	4.0/A+
	Operating limits	°C	-15°/24° Dry bulb		
Sound pressure level to 1 m		dB(A)	53	50	51
Sound power level		dB(A)	63	63	64
Airflow		m³/h	2900	2500	3500
Compressor type			Twin Rotary DC Inverter	Twin Rotary DC Inverter	Twin Rotary DC Inverter
Outline dimensions (WxHxD)		mm	810x288x688	890x353x697	890x353x697
Package dimensions (WxHxD)		mm	949x406x760	1005x423x815	1005x423x815
Net weight/Gross weight		kg	43/46.4	53/56	55/58
Part number			7SP091175	7SP091176	7SP091177
POWER SUPPLY					
Phase/Tension/Frequency			1P/230V/50Hz	1P/230V/50Hz	1P/230V/50Hz
Power supply side			Outdoor	Outdoor	Outdoor
Power cable section		mm²	3x2.5	3x2.5	3x2.5
Fuse rating am (D curve)		A	6.7	7.1	13
Electrical connections		mm²	4x1.5	4x1.5	4x1.5
PIPE LINE					
Suction pipe diameter		inches	2x3/8"	3x3/8"	3x3/8" + 1x1/2"
Liquid pipe diameter		inches	2x1/4"	3x1/4"	4x1/4"
Max. length		m	30	60	70
Max. length per circuit		m	20	25	25
Max. height between indoor and outdoor units		m	15	15	15
Max. height between indoor units		m	15	7.5	7.5
Refrigerant / GWP			R32/675	R32/675	R32/675
Charge		kg	1.2	1.6	2.5

COMPATIBLE
WITH

HIGH WALL
HDM 9/12/18/24



YDZA2-18 RESIDENTIAL MULTISPLIT DUO

Indoor units combinations	COOLING									HEATING								
	Rated power (kW)		Total power (kW)			Total input power (kW)			EER/ Energy label	Rated power (kW)		Total power (kW)			Total input power (kW)			COP/ Energy label
	Unit A	Unit B	Min.	Rated	Max.	Min.	Rated	Max.		Unit A	Unit B	Min.	Rated	Max.	Min.	Rated	Max.	
9+9	2.40	2.40	1.10	4.80	5.50	0.35	1.52	2.23	3.16/B	2.60	2.60	1.40	5.20	6.00	0.52	1.53	2.27	3.40/B
9+12	1.95	2.85	1.10	4.80	5.60	0.35	1.50	2.25	3.20/B	2.40	2.80	1.50	5.20	6.10	0.53	1.53	2.30	3.40/B
12+12	2.40	2.40	1.10	4.80	5.70	0.35	1.52	2.30	3.16/B	2.60	2.60	1.60	5.20	6.10	0.55	1.51	2.35	3.44/B



YDZA3-27 RESIDENTIAL MULTISPLIT TRIO











Indoor units combinations	COOLING									HEATING										
	Rated power (kW)			Total power (kW)			Total input power (kW)			EER/ Energy label	Rated power (kW)			Total power (kW)			Total input power (kW)			COP/ Energy label
	Unit A	Unit B	Unit C	Min.	Rated	Max.	Min.	Rated	Max.		Unit A	Unit B	Unit C	Min.	Rated	Max.	Min.	Rated	Max.	
9+9	2.60	2.60	-	2.00	5.20	7.40	0.55	1.52	2.68	3.42/A	3.60	3.60	-	2.90	7.20	8.50	0.55	1.93	2.10	3.73/A
9+12	2.60	3.60	-	2.00	6.20	7.60	0.55	1.79	2.99	3.46/A	3.38	4.22	-	2.90	7.60	8.50	0.55	2.05	2.10	3.71/A
9+18	2.33	4.67	-	2.40	7.00	7.60	0.55	2.00	3.00	3.50/A	2.85	4.75	-	2.90	7.60	8.50	0.55	2.05	2.10	3.71/A
12+12	3.40	3.40	-	2.40	6.80	7.60	0.55	2.00	3.20	3.40/A	3.75	3.75	-	2.90	7.50	8.50	0.55	1.93	2.20	3.90/A
12+18	2.86	4.14	-	2.40	7.00	7.60	0.55	1.82	3.20	3.85/A	3.26	4.34	-	2.90	7.60	8.50	0.55	2.00	2.20	3.80/A
9+9+9	2.33	2.33	2.33	2.40	7.00	7.60	0.55	1.76	2.70	3.98/A	2.53	2.53	2.53	2.90	7.60	8.50	0.55	1.81	2.30	4.20/A
9+9+12	2.07	2.07	2.86	2.40	7.00	7.60	0.55	1.78	2.70	3.93/A	2.34	2.34	2.92	2.90	7.60	8.50	0.55	1.84	2.30	4.13/A
9+12+12	1.86	2.57	2.57	2.40	7.00	7.60	0.55	1.78	2.70	3.93/A	2.17	2.71	2.71	2.90	7.60	8.50	0.55	1.84	2.30	4.13/A



YDZA4-30 RESIDENTIAL MULTISPLIT QUATTRO

Indoor units combinations	COOLING											HEATING										
	Rated power (kW)				Total power (kW)			Total input power (kW)			EER/ Energy label	Rated power (kW)				Total power (kW)			Total input power (kW)			COP/ Energy label
	Unit A	Unit B	Unit C	Unit D	Min.	Rated	Max.	Min.	Rated	Max.		Unit A	Unit B	Unit C	Unit D	Min.	Rated	Max.	Min.	Rated	Max.	
9+9	2.60	2.60	-	-	2.50	5.20	7.80	0.55	1.60	3.30	3.25/A	3.60	3.60	-	-	3.40	7.20	10.50	0.55	1.94	3.30	3.71/A
9+12	2.60	3.60	-	-	2.50	6.20	9.10	0.55	1.98	3.30	3.13/B	3.60	4.50	-	-	3.80	8.10	10.50	0.55	2.10	3.30	3.86/A
9+18	2.60	5.20	-	-	2.50	7.80	9.30	0.55	2.35	3.30	3.32/A	3.60	6.00	-	-	4.40	9.60	10.50	0.55	2.50	3.30	3.84/A
9+24	2.43	6.07	-	-	2.50	8.50	9.30	0.55	2.60	3.30	3.27/A	3.26	6.34	-	-	4.40	9.60	10.50	0.55	2.55	3.30	3.76/A
12+12	3.60	3.60	-	-	2.50	7.20	9.30	0.55	2.20	3.30	3.27/A	4.50	4.50	-	-	4.00	9.00	10.50	0.55	2.35	3.30	3.83/A
12+18	3.31	4.79	-	-	2.50	8.10	9.50	0.55	2.52	3.30	3.21/A	3.86	5.14	-	-	4.40	9.00	10.50	0.55	2.37	3.30	3.80/A
12+24	3.03	5.47	-	-	2.50	8.50	9.50	0.55	2.59	3.30	3.28/A	3.76	5.84	-	-	4.40	9.60	10.50	0.55	2.50	3.30	3.84/A
18+18	4.25	4.25	-	-	2.50	8.50	9.50	0.55	2.56	3.30	3.32/A	4.80	4.80	-	-	4.40	9.60	10.50	0.55	2.46	3.30	3.90/A
18+24	3.78	4.72	-	-	2.50	8.50	9.50	0.55	2.55	3.30	3.33/A	4.43	5.17	-	-	4.40	9.60	10.50	0.55	2.48	3.30	3.87/A
24+24	4.25	4.25	-	-	2.50	8.50	9.50	0.55	2.55	3.30	3.33/A	4.80	4.80	-	-	4.40	9.60	10.50	0.55	2.50	3.30	3.84/A
9+9+12	2.51	2.51	3.48	-	3.20	8.50	9.50	0.55	2.55	3.50	3.33/A	2.95	2.95	3.69	-	4.40	9.60	10.50	0.55	2.45	3.40	3.92/A
9+9+18	2.13	2.13	4.25	-	3.20	8.50	9.50	0.55	2.55	3.50	3.33/A	2.62	2.62	4.36	-	4.40	9.60	10.50	0.55	2.45	3.40	3.92/A
9+9+24	1.89	1.89	4.72	-	3.20	8.50	9.50	0.55	2.55	3.50	3.33/A	2.43	2.43	4.73	-	4.40	9.60	10.50	0.55	2.45	3.40	3.92/A
9+12+12	2.26	3.12	3.12	-	3.20	8.50	9.50	0.55	2.55	3.50	3.33/A	2.74	3.43	3.43	-	4.40	9.60	10.50	0.55	2.45	3.40	3.92/A
9+12+18	1.94	2.68	3.88	-	3.20	8.50	9.50	0.55	2.55	3.50	3.33/A	2.45	3.06	4.09	-	4.40	9.60	10.50	0.55	2.45	3.40	3.92/A
9+12+24	1.74	2.41	4.35	-	3.20	8.50	9.50	0.55	2.55	3.50	3.33/A	2.29	2.86	4.45	-	4.40	9.60	10.50	0.55	2.45	3.40	3.92/A
12+12+12	2.83	2.83	2.83	-	3.20	8.50	9.50	0.55	2.53	3.50	3.36/A	3.20	3.20	3.20	-	4.40	9.60	10.50	0.55	2.45	3.40	3.92/A
12+12+18	2.47	2.47	3.56	-	3.20	8.50	9.50	0.55	2.53	3.50	3.36/A	2.88	2.88	3.84	-	4.40	9.60	10.50	0.55	2.43	3.40	3.95/A
12+12+24	2.23	2.23	4.03	-	3.20	8.50	9.50	0.55	2.53	3.50	3.36/A	2.70	2.70	4.20	-	4.40	9.60	10.50	0.55	2.43	3.40	3.95/A
12+18+18	2.19	3.16	3.16	-	3.20	8.50	9.50	0.55	2.53	3.50	3.36/A	2.62	3.49	3.49	-	4.40	9.60	10.50	0.55	2.43	3.40	3.95/A
9+9+9+9	2.13	2.13	2.13	2.13	3.20	8.50	9.50	0.55	2.50	3.50	3.40/A	2.40	2.40	2.40	2.40	4.40	9.60	10.50	0.55	2.40	3.40	4.00/A
9+9+9+12	1.94	1.94	1.94	2.68	3.20	8.50	9.50	0.55	2.50	3.50	3.40/A	2.26	2.26	2.26	2.82	4.40	9.60	10.50	0.55	2.40	3.40	4.00/A
9+9+9+18	1.70	1.70	1.70	3.40	3.20	8.50	9.50	0.55	2.50	3.50	3.40/A	2.06	2.06	2.06	3.43	4.40	9.60	10.50	0.55	2.40	3.40	4.00/A
9+9+12+12	1.78	1.78	2.47	2.47	3.20	8.50	9.50	0.55	2.50	3.50	3.40/A	2.13	2.13	2.67	2.67	4.40	9.60	10.50	0.55	2.40	3.40	4.00/A
9+9+12+18	1.58	1.58	2.19	3.16	3.20	8.50	9.50	0.55	2.50	3.50	3.40/A	1.95	1.95	2.44	3.25	4.40	9.60	10.50	0.55	2.40	3.40	4.00/A
9+12+12+12	1.65	2.28	2.28	2.28	3.20	8.50	9.50	0.55	2.50	3.50	3.40/A	2.02	2.53	2.53	2.53	4.40	9.60	10.50	0.55	2.40	3.40	4.00/A
12+12+12+12	2.13	2.13	2.13	2.13	3.20	8.50	9.50	0.55	2.50	3.50	3.40/A	2.40	2.40	2.40	2.40	4.40	9.60	10.50	0.55	2.40	3.40	4.00/A

Monobloc & Floor Standing ranges

MODEL NAME	Fluid type	Page	kBTU/h kW	9 2.5	12 3.5	48 12.5
UPGRADE						
 ON/OFF PORTABLE Portable solution	MAF	R410A	74	 	 	
 WINDOW Prefabricated buildings solution	WFD	R32	75			
NEW						
 FLOOR STANDING High volume room	SDM	R410A	76			

→ **The economic solution**
for large volume rooms



Fixed Speed
Cooling only

MAF

ON/OFF PORTABLE



UPGRADE



+ PRODUCTS

- No fluid handling.
- Economic.



RC08C included

FEATURES

TECHNOLOGY:



R410A FLUID

AIR QUALITY / CLEAN:



ANTIBACTERIA FILTER



AUTO CLEAN/DRY

USER FUNCTIONS:



I FEEL



SLEEP MODE



AUTO RESTART (MEMORY)



REMOTE CONTROL LOCK

INSTALLER FUNCTIONS:



SELF DIAGNOSTIC

- Comfort "I Feel": temperature sensor in the remote control RC08C.
- Mobile air conditioning: unit on swivel castors and side handles.
- Control screen on the unit.
- Installation kit for windows and walls as standard.
- Limitation of the amount of condensate (evaporation on the exchanger).



MAF TECHNICAL DATA

Indoor units		AWPO-MAF009-C11	AWPO-MAF012-C11
Phase		Single phase	Single phase
COOLING			
Rated power (min./max.)	kW	2.64	3.52
Rated power input	kW	1.01	1.35
EER/Energy label		2.60/A	2.61/A
Operating limits	°C	17°/35° Dry bulb	
INDOOR UNIT			
Type		Monobloc	Monobloc
Sound pressure level to 1 m (LS/MS/HS)	dB(A)	49/50/52	46/49/52
Sound power Level	dB(A)	65	65
Airflow (LS/MS/HS)	m³/h	350/375/420	370
Diameter flexible emission duct	mm	150	
Length range of heat emission duct	m	0.50 - 1.5	
Dehumidification	l/h	1.6	1.8
Outline dimensions (WxHxD)	mm	467x765x397	467x765x397
Package dimensions (WxHxD)	mm	515x880x443	517x880x437
Net weight/Gross weight	kg	29/34.1	33.5/37
Part number		7MB021058	7MB021057
POWER SUPPLY			
Phase/Tension/Frequency		1P/230V/50Hz	1P/230V/50Hz
PIPE LINE			
Refrigerant / GWP		R410A/2088	R410A/2088
Charge	kg	0.43	0.54

* Packing 8 pieces minimum



- DC Inverter compressor technology that guarantees energy savings.
- Ideal solution for modular constructions.
- Control screen on the unit.

+ PRODUCTS

- Unique solution.
- R32 refrigerant with low environmental impact.
- No fluid handling.



WFD RC included

FEATURES

TECHNOLOGY:



DC INVERTER



R32 FLUID

USER FUNCTIONS:



SLEEP MODE



AUTO RESTART (MEMORY)

INSTALLER FUNCTIONS:



SELF DIAGNOSTIC

WFD TECHNICAL DATA

Indoor units		AWWR-WFD009-C11	AWWR-WFD012-C11
Phase		Single phase	Single phase
COOLING			
Rated power (min./max.)	kW	2.75	3.7
Pdesignnc	kW	2.75	3.7
Rated power input	kW	0.81	1.09
SEER/Energy label		5.10/A	5.10/A
Operating limits	°C	18°/43° Dry bulb	
INDOOR UNIT			
Sound pressure level to 1 m (LS/MS/HS)	dB(A)	45/47/49	45/47/49
Airflow (LS/MS/HS)	m³/h	310/350/380	400/450/490
Dehumidification	l/h	1.0	1.2
Compressor type		Rotary	Rotary
Outline dimensions (WxHxD)	mm	560x375x710	660x428x700
Package dimensions (WxHxD)	mm	623x425x806	739x515x793
Net weight/Gross weight	kg	34/36.7	46/50
Part number		7WT010008	7WT010009
POWER SUPPLY			
Phase/Tension/Frequency		1P/230V/50Hz	1P/230V/50Hz
Power supply side		Indoor	Indoor
Power cable section	mm²	3x1.0	3x1.5
Fuse rating am (D curve)	A	10	10
PIPE LINE			
Refrigerant / GWP		R32/675	R32/675
Charge	kg	0,51	0,63





NEW

+ PRODUCTS

- DC Inverter technology.
- Commercial application.



RC09

FEATURES

TECHNOLOGY:



DC INVERTER



R410A FLUID



ELECTRONIC EXPANSION VALVE

AIR QUALITY / CLEAN:



AIR FILTER



AUTO CLEAN/DRY

INSTALLER FUNCTIONS:



DIGITAL DISPLAY



SELF DIAGNOSTIC





- High efficiency (SEER greater than 5) which brings energy savings throughout the year.
- Long blowing distance (up to 15m).
- Display and control screen on the unit.

SDM TECHNICAL DATA

Indoor unit		AW-SDM048-N11
Outdoor unit		AW-YSDM048-H11
Phase		Single phase
COOLING		
Rated power (min./max.)	kW	12.5 (6.0-14.5)
Rated power input	kW	3.90 (2.0-6.0)
SEER/Energy label		5.1/A
Operating limits	°C	-10°/46° Dry bulb
HEATING		
Rated power (min./max.)	kW	13.0 (6.0-16.5)
Rated power input	kW	4.05 (2.0-6.0)
SCOP/Energy label		3.4/A
Operating limits	°C	-15°/24° Dry bulb
INDOOR UNIT		
Sound pressure level to 1.5 m (LS/MS/HS)	dB(A)	44/48/51
Sound power level	dB(A)	69
Airflow (LS/MS/HS)	m³/h	1350/1500/1750
Dehumidification	l/h	5
Outline dimensions (WxHxD)	mm	1850x600x350
Package dimensions (WxHxD)	mm	1986x691x415
Net weight/Gross weight	kg	57/65
Part number		7SP011088
OUTDOOR UNIT		
Sound pressure level to 1 m	dB(A)	59
Sound power level	dB(A)	73
Airflow	m³/h	4200
Compressor type		Twin rotary
Outline dimensions (WxHxD)	mm	1008x830x410
Package dimensions (WxHxD)	mm	1142x1000x498
Net weight/Gross weight	kg	82/93
Part number		7SP062971
POWER SUPPLY		
Phase/Tension/Frequency		1P/230V/50Hz
Power supply side		Extérieur
Power cable section	mm²	3x4
Fuse rating am (D curve)	A	25
Electrical connections	mm²	4x2.5
PIPE LINE		
Suction pipe diameter	inches	3/4"
Liquid pipe diameter	inches	3/8"
Max. length	m	50
Max. height	m	30
Refrigerant / GWP		R410A/2088
Charge (5m)	kg	2.85

COMBINATIONS

Indoor unit	Compatible with outdoor unit
Floor standing	Monosplit
<p>SDM</p> 	<p>YSDM</p> 

Water range

MODEL NAME	Fluid type	Page	kBTU/h kW	7 2	9 2.5	12 3.5	18 5	24 7
 ON/OFF WATER CONSOLE Monobloc	CAO	R407C	80	●		●	●	

UPGRADE

 ON/OFF WATER SOURCE Split system	GCAO + CAF/ DAF	R410A	82		●	●	●	●
--	--------------------------	-------	----	--	---	---	---	---



CAO Monobloc solution

- Ideal solution for buildings subject to **local or aesthetic restrictions**.
- **Simple and fast installation**.
- Ideal solution for cases where **access to an outside wall is impossible**.

Hydraulic fittings



GCAO Split solution

Liaisons frigorifiques



Hydraulic fittings

Fixed Speed
Cooling only

CAO

ON/OFF WATER CONSOLE



Monobloc solution

Unique solutions



- Electrical heater in option.
- Ideal indoor solution when the building structure or aesthetic reasons forbid a condensing outdoor unit.
- Pressure valve supplied.

+ PRODUCTS

- No outdoor unit.
- No fluid handling.
- Can be connected to public water network.
- French product.

FEATURES

TECHNOLOGY:



CAO TECHNICAL DATA

Indoor units		CAO 230	CAO 370	CAO 580
Phase		Single phase	Single phase	Single phase
COOLING				
Rated power (min./max.)	kW	2.3	3	4.7
Rated power input	kW	0.66	0.85	1.3
EER/Energy label		3.4/E	3.5/D	3.6/D
Operating limits	°C	15°/32° Dry bulb		
Condenser inlet water temperature		10°/30°		
INDOOR UNIT				
Sound pressure level to 1 m (LS/HS)	dB(A)	37/40	38/41	41/43
Fresh air intake	m³/h	60	60	80
Airflow (LS/HS)	m³/h	450/550	450/550	725/880
Water flow at +15°C	l/h	130	170	270
Compressor type		Rotary	Rotary	Rotary
Dimensions (WxHxD)	mm	1030x620x226	1030x620x226	1390x620x226
Weight	kg	48	49	69
Part number		7CW011016	7CW011017	7CW011018
POWER SUPPLY				
Phase/Tension/Frequency		1P/230V/50Hz	1P/230V/50Hz	1P/230V/50Hz
Power supply side		Indoor	Indoor	Indoor
Power cable section	mm²	3x1.5	3x1.5	3x1.5
Fuse rating am (D curve)		6	6	8
PIPE LINE				
Refrigerant / GWP		R407C/1774	R407C/1774	R407C/1774
Charge	kg	0.41	0.475	0.603

OPTIONS

Accessory	Part number	Function
Electrical heater 2/3 kW	7ACEL0006	Simple electrical additional heater 2/3 kW - CAO 230 and 370.
Electrical heater 4.7 kW	7ACEL0007	Simple electrical additional heater 4.7 kW - CAO 580
Simple wired remote control	7ACEL0039	Simple function as ON/OFF, operating mode temperature.

A series of horizontal dotted lines for writing.



Fixed Speed
Cooling only

GCAO

ON/OFF WATER SOURCE



UPGRADE

Unique solutions



+ PRODUCTS

- No outdoor unit.
- Can be connected to public water network.
- Compact design.



RC08A
(Included with HHF and CAF)



RCWE
(Included with DAF)

FEATURES

TECHNOLOGY:



R410A FLUID

AIR QUALITY / CLEAN:



AUTO CLEAN/DRY

INSTALLER FUNCTIONS:



SLEEP MODE



AUTO RESTART (MEMORY)



REMOTE CONTROL LOCK



No outdoor unit

COMPATIBLE WITH



HIGH WALL HHF



CASSETTE CAF

+ adaptor



DUCTED MEDIUM STATIC PRESSURE DAF

+ adaptor

- Preserved architecture of the building: Water solution without outside grou.
- Water flow protection by pressure valve.
- Protection of the unit via a high pressure switch with manual reset.
- Super quiet.
- Connection to HHF high wall, CAF cassette and DAF ducted units.
- Connection to recycled or lost water systems.

OPTIONS

Accessory	Part number	Photo	Function
Additional adaptor refer to all CAF/DAF	7ACEL1746		Electronic adaptor between IDU CAF/DAF and ODU GCAO.

GCAO TECHNICAL DATA

Outdoor units		GCAO 9N	GCAO 12N	GCAO 18N	GCAO 24N
Phase		Single phase	Single phase	Single phase	Single phase
COOLING					
Rated power (min./max.)	kW	2.70	3.65	5.85	6.37
Rated power input	kW	0.68	0.94	1.34	1.90
EER/Energy label		4.19/A	3.88/B	4.37/A	3.76/B
Operating limits indoor temperature	°C	17°/32° Dry bulb			
Condenser inlet water temperature	°C	10°/45°			
WATER SOURCE					
Sound power level to 1 m	dB(A)	49	49	51	53
Waste water flow at + 15°C	l/h	120	160	250	320
Recycled water flow 30/35°C	l/h	600	850	1 250	1 550
Compressor type		Rotary	Rotary	Rotary	Rotary
Hydraulic connection pipe	inches	3/4"	3/4"	3/4"	3/4"
Dimensions (WxHxD)	mm	625x473x360	625x473x360	625x473x360	625x473x360
Weight	kg	41	45	50	56
Part number		7SP101040	7SP101041	7SP101045	7SP101044
PIPE LINE					
Suction pipe diameter	inches	3/8"	1/2" *	1/2"	1/2"
Liquid pipe diameter	inches	1/4"	1/4"	1/4"	1/4"
Max. length	m	25	25	25	25
Max. height	m	15	15	15	15
INDOOR UNIT					
Phase/Tension/Frequency		1P/230V/50Hz			
Power supply side		Indoor	Indoor	Indoor	Indoor
Power cable section	mm²	3x1.5	3x1.5	3x1.5	3x2.5
Fuse rating am (D curve)	A	10	10	10	16
Electrical connections	mm²	3x1.5	3x1.5	3x1.5	4x2.5
Refrigerant / GWP		R410A/2088	R410A/2088	R410A/2088	R410A/2088
Charge	kg	0.49	0.57	0.73	1.16

Indoor units high wall		AWSI-HHF009-N11*	AWSI-HHF012-N11	AWSI-HHF018-N11	AWSI-HHF024-N11
Sound pressure level to 1 m (LS/MS/HS/SS)	dB(A)	32/35/37/40	32/35/38/41	35/39/42/45	38/41/44/47
Sound power level (LS/MS/HS/SS)	dB(A)	42/45/47/50	42/45/48/51	45/49/52/55	48/51/54/57
Airflow (LS/MS/HS/SS)	m³/h	310/340/370/400	350/420/500/550	550/650/780/850	550/650/780/850
Dimensions (WxHxD)	mm	730x255x174	790x265x177	940x298x200	940x298x200
Weight	kg	8	9	13	13
Part number		7SP023085	7SP023086	7SP023087	7SP023088

Indoor units cassettes		AWSI-CAF012-N11**	AWSI-CAF012-N11	AWSI-CAF018-N11	AWSI-CAF024-N11
Sound pressure level to 1 m (LS/MS/HS)	dB(A)	38/40/42	38/40/42	46/47/49	46/47/48
Sound power level (LS/MS/HS)	dB(A)	48/50/52	48/50/52	56/57/59	56/57/58
Airflow (LS/MS/HS)	m³/h	420/490/560	420/490/560	620/650/690	1230/1280/1340
Dimensions (WxHxD)	mm	665x240x595	665x240x595	665x240x595	840x240x840
Frame dimensions (WxHxD)	mm	670x50x670	670x50x670	670x50x670	950x60x950
Weight	kg	19.5	19.5	20	27
Part number		7SP042257	7SP042257	7SP042252	7SP042253
Frame part number		7ACVF0567	7ACVF0567	7ACVF0567	7ACVF0555
Electronic adaptor between IDU CAF to ODU GCAO	Part nb.	7ACEL1746			
IR remote control RC08A		included			
Wired remote control RCWE	Part nb.	7ACEL1647			



Indoor units ducted		AWSI-DAF012-N11**	AWSI-DAF012-N11	AWSI-DAF018-N11	AWSI-DAF024-N11
Sound pressure level to 1 m (LS/MS/HS)	dB(A)	29/30/33	29/30/33	32/34/38	44/45/46
Sound power level (LS/MS/HS)	dB(A)	39/40/43	39/40/43	42/44/48	54/55/56
Airflow (LS/MS/HS)	m³/h	520/560/660	520/560/660	810/920/1070	1190/1270/1330
External static pressure	Pa	25	25	25	37
Dimensions (WxHxD)	mm	1015x275x720	1015x275x720	1260x270x555	1260x270x555
Weight	kg	31	31	33	34
Part number		7SP032177	7SP032177	7SP032171	7SP032172
Electronic adaptor between IDU DAF to ODU GCAO	Part nb.	7ACEL1746			
Wired remote control RCWE		included			
IR remote control RC08A		Optional			
Wired remote control RCW4	Part nb.	7ACEL1613			
Electronic adaptor between IDU DAF to ODU GCAO	Part nb.	7ACEL1653			

* To connect HHF 12, a flare adapter: 1/2" Female x 3/8" Male is mandatory.

** CAF/DAF 12 matching with GCAO 9.



Light Commercial range

MODEL NAME		Fluid type	Page	kW	8	12.5	14	17	19	25	30	40	45	55
VERTICAL CABINET		X AC	R407C	86		●		●	●		●	●		●
	VERTICAL AIR CABINET		Electromechanical system											
		CONA	R407C	86		●		●	●		●	●		●
AIR CONDENSER		Independant group												
		X WC	R407C	90	●		●	●		●	●		●	
VERTICAL WATER CABINET		Electromechanical system												

- **Industrial** application
- **Wide power range**
- **High reliability**



Fixed Speed
Cooling only

X AC

VERTICAL AIR CABINET



Plenum optional

X AC range is
electromechanical
→ High reliability



+ PRODUCTS

- Easy installation and maintenance.
- “Plug & Play” for replacement.
- Air discharge through duct network or plenum.
- Adjustable available static pressure.

FEATURES

TECHNOLOGY:



MAIN OPTIONS

- Room thermostat.
- Hot water heating coil.
- “All seasons” system (cooling mode operation down to outdoor temperature of -10°C).
- Remote fault reporting.
- Plenum, fresh air.
- Pipe link (10 m).

- Split system with outdoor condenser fan unit.
- Temperature control by thermostat on the front frame or by a remote control (optional).
- Electrical, refrigeration and thermal protection devices.
- Available with or without neutral in 3P/400V/50Hz.
- “High ventilation” in standard for XAC 1200 and 1900.
- “Plug & Play” to replace old Airwell vertical cabinet.
- High ventilation kit and electrical heater factory mounted or in accessory on demand.

OPERATING LIMIT FOR STANDARD UNIT

Indoor unit

Minimum air temperature (room/intake/around unit)	21°C DB/15°C WB
Maximum air temperature (room/intake/around unit)	32°C DB/23°C WB

Outdoor unit

Minimum air temperature/with all-season kit	15°C DB/-10°C
Maximum air temperature	50°C DB

X AC TECHNICAL DATA

Indoor units		X AC 1200	X AC 1900	X AC 2450	X AC 3250	X AC 4650	X AC 6450	
Phase		Three phases	Three phases	Three phases	Three phases	Three phases	Three phases	
PART NUMBER								
Standard with neutral	Part nb.	7XU122245	7XU122267	7XU122078	7XU122079	7XU122080	7XU122081	
With electrical heater	Part nb.	7XU122248	7XU122249	7XU122250	7XU122251	7XU122252	7XU122253	
With high ventilation	Part nb.	7XU122245	7XU122267	7XU122256	7XU122257	7XU122258	7XU122259	
Without neutral	Part nb.	7XU122266	On demand	7XU12221S	7XU12222S	7XU12224S	7XU12227S	
RATED POWER								
Cooling	Power	kW	12.3	16.2	19.8	29.0	38.9	55.0
	Nominal power input Cooling + Ventilation (SV/HV)	kW	4.2/4.4	5.7/6.2	7.1/7.5	10.2/11.3	15/16	22.2/23.7
	Nominal power input Electrical Heating + Ventilation (SV/HV)	kW	7.6/8	9.2/10.4	13.6/14	16.8/17.6	28.8/6	35.2/36.4
	EER		2.93	2.84	2.78	2.84	2.6	2.5
	Cooling circuit	nb	1	1	1	1	2	2
INDOOR UNIT								
Phase/Tension/Frequency		3P/400V/50Hz + neutral depending on models						
Ventilation	Available static pressure	Pa	200	300	200	200	250	290
	Available static pressure (HV)	Pa	200	380	400	400	480	480
	Nominal airflow	m³/h	2000	3200	4500	5800	9000	12000
	Airflow range (min/max)	m³/h	1500/2500	2500/3800	3600/5400	4600/7000	7200/10800	9500/14500
Sound levels	Sound power level	dB(A)	56	68	75	81	77	85
Dimensions	WxHxD	mm	890x1540x430	1000x1735x500	1300x1840x600	1530x1840x600	1715x1970x790	1980x1970x790
	Plenum height	mm	220	260	350	350	400	400
Weight	Indoor unit	kg	136	182	265	350	525	600
ACCESSORIES								
Hot water coil	kW	15.5	29.7	38.5	50	77	94	
	Part nb.	7ACFH0062	7ACFH0063	7ACFH0064	7ACFH0118	7ACFH0180	7ACFH0170	
ON/OFF switch and room thermostat	Part nb.	7ACEL0041	7ACEL0041	7ACEL0032	7ACEL0032	7ACEL0032	7ACEL0032	
Remote fault reporting	Part nb.	On demand	On demand	7ACEL0072	7ACEL0072	7ACEL0071	7ACEL0071	
Air distribution duct frame	Part nb.	7ACVF0582	7ACVF0102	7ACVF0050	7ACVF0051	7ACVF0052	7ACVF0052	
Total rear air intake duct frame	Part nb.	7ACVF0041	7ACVF0104	7ACVF0043	7ACVF0044	7ACVF0045	7ACVF0046	
Front air distribution plenum	Part nb.	7ACVF0105	7ACVF0106	7ACVF0108	7ACVF0109	7ACVF0110	7ACVF0111	
Fresh air supplied	Part nb.	7ACVF0047	7ACVF0047	On demand	On demand	On demand	On demand	

COMBINATIONS

X AC 1200	X AC 1900	X AC 2450	X AC 3250	X AC 4650	X AC 6450
CONA 34	CONA 54	CONA 74	CONA 104	CONA 148	CONA 208
-	-	-	-	= 2 x CONA 74	= 2 x CONA 104

Fixed Speed
Cooling only

CONA AIR CONDENSER



COMPATIBLE WITH

VERTICAL AIR CABINET XAC



FEATURES

TECHNOLOGY:



R407C FLUID

OPTIONS OBLIGATOIRES

- Set of female valves.

DONNÉES TECHNIQUES CONA

Outdoor units			CONA 34	CONA 54	CONA 74	CONA 104	CONA 148 (2 X CONA 74)	CONA 208 (2 X CONA 104)
Phase			Three phases	Three phases	Three phases	Three phases	Three phases	Three phases
PART NUMBER								
With neutral	Standard	Part nb.	7XU131025	7XU131026	7XU131027	7XU131028	2 x 7XU131027	2 x 7XU131028
	With all seasons control	Part nb.	7XU131083	7XU131059	7XU131058	7XU131060	2 x 7XU131058	2 x 7XU131060
Without neutral	With all seasons control	Part nb.	7XU131084	7XU131068S	7XU131064S	7XU131063S	2 x 7XU131064S	2 x 7XU131063S
OUTDOOR UNIT								
Phase/Tension/Frequency			3P/400V/50Hz					
Condenser unit			1	1	1	1	2	2
Ventilation	Max. airflow	m ³ /h	8600	7600	8550	14000	8550	14000
	Speed	tr/mn	870					
Sound levels	Sound power level	dB(A)	52	58	61	73	64	76
Dimensions	WxHxD	mm	885x840x825	885x840x825	1141x840x885	1546x840x885	1141x840x885	1546x840x885
Weight	Outdoor unit	kg	59	68	93	130	93	130
Pipe line	Suction pipe diameter	inches	1/2"	1/2"	5/8"	3/4"	5/8"	3/4"
	Liquid pipe diameter	inches	3/8"	3/8"	1/2"	5/8"	1/2"	5/8"
	Max. length	m	45	45	45	45	45	45
Refrigerant / GWP			R407C/1774	R407C/1774	R407C/1774	R407C/1774	R407C/1774	R407C/1774
Charge		kg	1.22	1.704	7.6	9.8		
ACCESSORIES								
Set of female valves		Part nb.	7ACFH0054	7ACFH0055	7ACFH0056	7ACFH0061	7ACFH0057	7ACFH0060
Pipe link - Length 10m		Part nb.	7ACFH0210	7ACFH0211	7ACFH0212	7ACFH0213	7ACFH0214	7ACFH0215

A series of horizontal dotted lines for writing.

Fixed Speed
Cooling only

X WC

VERTICAL WATER CABINET



UPGRADE



+ PRODUCTS

- Easy installation and maintenance.
- Public or recycled water operation.
- Air discharge through duct network or plenum.
- Adjustable available static pressure.

FEATURES

TECHNOLOGY:



R407C FLUID

MAIN OPTIONS

- Room thermostat.
- Electrical heater.
- Hot water heating coil.
- Remote fault reporting.
- Plenum.
- Duct flange.



Plenum optional

- Monobloc system.
- Temperature control by thermostat on the front frame or by a remote control (optional).
- Electrical, refrigeration and thermal protection devices.
- “High ventilation” in standard for CX25, XWC 1200 and 1900.
- “Plug & Play” to replace old Airwell vertical cabinet.

OPERATING LIMIT FOR STANDARD UNIT

Cooling Mode

Minimum air temperature	21°C DB/15°C WB
Maximum air temperature	32°C DB/23°C WB
Minimum water temperature	+10°C
Maximum water temperature	+30°C

X WC TECHNICAL DATA

Indoor units			CX 25	X WC 1200	X WC 1900	X WC 2450	X WC 3250	X WC 4650	
Phase			Three phases	Three phases	Three phases	Three phases	Three phases	Three phases	
PART NUMBER									
3P/400V/50Hz	With valve	Part nb.	7XU012192	7XU012190	7XU012187	7XU012029	7XU012030	7XU012031	
RATED POWER									
Cooling	Power		kW	8	15.0	18.0	23.0	32.4	45.7
	Nominal power input Cooling + Ventilation (SV/HV)	Wasted water	kW	2.1/2.6	3.8/4	5.1/5.6	6.4/6.8	9.2/10.3	13.5/14.5
		Recycled water	kW	-	3.6/3.8	4.6/5.1	5.8/6.2	8.3/9.4	12.4/13.4
	Nominal power input Electrical Heating + Ventilation (SV/HV)		kW	3.8/4.6	9.4/9.6	9.2/10.4	13.6/14	16.8/17.6	28.8/30
	EER			3.80	3.94	3.52	3.59	3.52	3.38
	Cooling circuit			1	1	1	1	1	2
VENTILATION									
Available static pressure		Pa	100	200	250	230	250	250	
Available static pressure (HV)		Pa	320	380	400	400	480	480	
Nominal airflow		m³/h	1500	2000	3200	4500	5800	9000	
Airflow range (min/max)		m³/h	1200/1850	1500/2500	2500/3800	3600/5400	4600/7000	7200/10800	
HYDRAULIC CIRCUIT									
Wasted water	Water flow	m³/h	0.34	0.91	0.95	1	1.7	2.8	
	Pressure drop	kPa	6	37	30	22	35	18	
Recycled water	Water flow	m³/h	1.47	3.16	3.05	4.3	5.8	8.3	
	Pressure drop	kPa	35	80	65	60	40	56	
Refrigerant / GWP			R407C/1774	R407C/1774	R407C/1774	R407C/1774	R407C/1774	R407C/1774	
Charge		kg	1.18	1.22	2.269 Wasted water/ 2.85 Recycled water	5.22	6.615		
SOUND LEVELS									
Sound power level*		dB(A)	51	51	55	58	64	60	
POWER SUPPLY									
Phase/Tension/Frequency			3P/400V/50Hz/N						
DIMENSIONS									
Indoor unit (WxHxD)		mm	800x1280x407	890x1540x404	1000x1735x474	1300x1840x600	1530x1840x600	1715x1970x790	
Plenum height		mm	300	220	260	350	350	400	
WEIGHT									
Indoor unit		kg	125	151	199	305	380	565	
ACCESSORIES									
Electric heater (3P/400V/50Hz)	kW		5.4	9	12	18	22.5	37.5	
	Part nb.		7ACEL0018	7ACEL0042	7ACEL0043	7ACEL0057	7ACEL0058	7ACEL0116	
Hot water coil	kW		-	15.5	29.7	38.5	50	77	
	Part nb.		-	7ACFH0062	7ACFH0063	7ACFH0064	7ACFH0118	7ACFH0180	
ON/OFF switch and room thermostat	Part nb.		7ACEL0030	7ACEL0041	7ACEL0041	7ACEL0032	7ACEL0032	7ACEL0032	
Sum heating resistance	Part nb.		7ACEL0027	7ACEL0029	included	-	-	-	
Remote fault reporting	Part nb.		-	-	-	7ACEL0072	7ACEL0072	7ACEL0071	
Air distribution duct frame	Part nb.		-	7ACVF0101	7ACVF0102	7ACVF0050	7ACVF0051	7ACVF0052	
Total rear air intake duct frame	Part nb.		-	7ACVF0041	7ACVF0104	-	-	-	
Front air distribution plenum	Part nb.		7ACVF0112	7ACVF0105	7ACVF0106	7ACVF0108	7ACVF0109	7ACVF0110	
Fresh air supplied	Part nb.		-	7ACVF0047	7ACVF0047	-	-	-	

* Total sound pressure dB(A) (4m) under nominal conditions in a room of 1000m³ (reverberation 0.83s).

VRF Range

Outdoor groups

MODEL NAME		Fluid type	Page	Capacity (HP)	Cooling power (kW)	Heating power (kW)	
MINI FLOWLOGIC II	NEW YCV080		R410A	98	3	8	9.5
	UPGRADE YCV150		R410A	98	5	15	17
	UPGRADE YCV180				6	18	20
	UPGRADE YCVFD280		R410A	98	10	28	31.5
FLOWLOGIC III	YDV280		R410A	100	10	28	31.5
	YDV400				14	40	45
	YDV450				16	45	50
	YDV504		R410A	100	18	50.4	56.5
	YDV560				20	56	63
	YDV680				24	68	73
NEW FLOWLOGIC II HR	YCV280HR		R410A	110	10	28	31.5
	YCV335HR		R410A	110	12	33.5	37.5
	YCV400HR				14	40	45
	YCV450HR				16	45	50
WATER FLOWLOGIC	NEW YWC		R410A	110	22.4	8	25.0
					28.0	10	31.5
					33.5	12	37.5

Capacity (HP)	Cooling power (kW)	Heating power (kW)	OUTDOOR UNITS	INDOOR UNITS	
			Combinations Mini FlowLogic II & FlowLogic III	Maximum indoor units connectable	Range cooling power connectable* (kW)
3	8	9.5	1XYCV080	5	4 - 10.4
5	15	17	1 X YCV150	8	7.5 - 19.5
6	18	20	1 X YCV180	9	9 - 23
10	28	31.5	1 X YCVFD280 ou 1 X YDV280	16 or 20	14 - 36
14	40	45	1 X YDV400	29	20 - 52
16	45	50	1 X YDV450	33	22.5 - 58.5
18	50.4	56.5	1 X YDV504	37	25.2 - 65.5
20	56	63	1 X YDV560	41	28 - 72
24	68	76.5	1 X YDV680	49	34 - 88
28	80	87.5	2 X YDV400	58	40 - 104
30	85	95	1 X YDV400 + 1 X YDV450	62	43 - 110.5
32	90	100	1 X YDV400 + 1 X YDV504	64	45 - 117
34	96	108	1 X YDV450 + 1 X YDV560	64	48 - 124.5
36	101	113	1 X YDV450 + 1 X YDV560	64	51 - 131
38	108	119	1 X YDV504 + 1 X YDV560	64	54 - 140
40	113	126.5	2 X YDV560	64	57 - 146.5
44	123.5	137.5	1 X YDV560 + 1 X YDV680	64	62 - 160.5
48	135	150	2 X YDV680	64	68 - 175.5
50	140.8	158	1 X YDV400 + 2 X YDV504	64	70.4 - 183.04
52	146	163	2 X YDV450 + 1 X YDV560	64	73 - 189.8
54	151.4	169.5	1 X YDV450 + 1 X YDV504 + 1 X YDV560	64	75.7 - 196.82
56	157	176	2 X YDV450 + 1 X YDV560	64	78.5 - 204.1
58	162.4	182.5	1 X YDV504 + 2 X YDV560	64	81.2 - 211.12
60	168	189	3 X YDV560	64	84 - 218.4
64	180	199	2 X YDV560 + 1 X YDV680	64	90 - 234
68	192	209	1 X YDV560 + 2 X YDV680	64	96 - 249.6
72	204	219	3 X YDV680	64	102 - 265.2

* Indoor total capacity can be 50% - 130% of outdoor capacity.

VRF Range Indoor units

MODEL NAME			Fluid type	Page
HIGH WALL	HBV		R410A	120
UPGRADE CASSETTE 600X600	CBV		R410A	121
CASSETTE 900X900	CCV		R410A	122
FLOOR CEILING	FAV		R410A	123
DUCTED LOW STATIC PRESSURE	DAV		R410A	124
DUCTED MEDIUM STATIC PRESSURE	DBV		R410A	125
DUCTED HIGH STATIC PRESSURE	DCV		R410A	126
CONSOLE	EAV		R410A	127
AHU CONNECTION KIT				128

Capacity (kBtu/h)	5	7	9	12	16	18	24	28	30	38	48	72	96	192
Capacity (HP)	0.5	0.75	1.25	1.5	1.75	2.25	3	3.5	3.75	4.75	6	9	12	24
Cooling (kW)	1.5	2.2	2.8	3.6	4.5	5.6	7.1	8	9	11.2	14	22.6	28	56
Heating (kW)	1.7	2.5	3.2	4	5	6.3	8	9	10	12.5	16	25	31.5	63

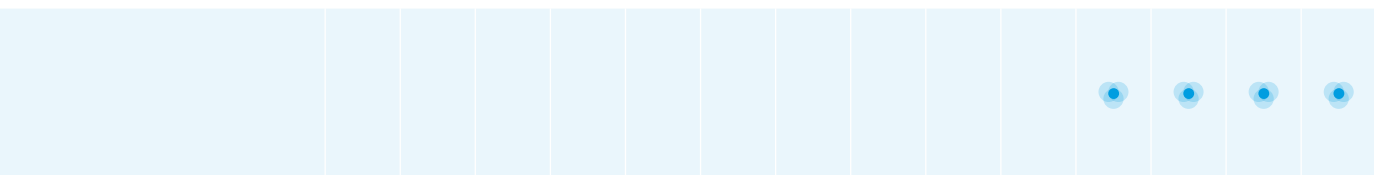
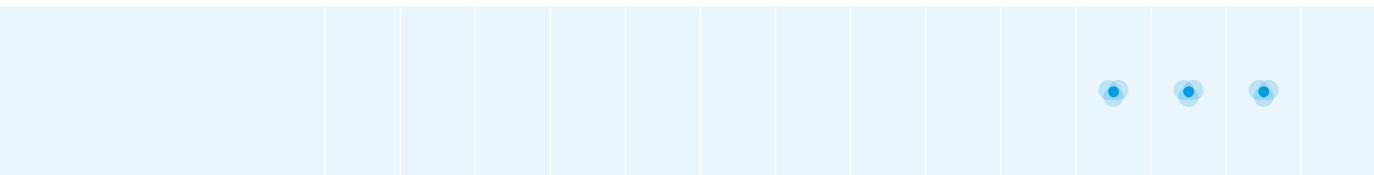
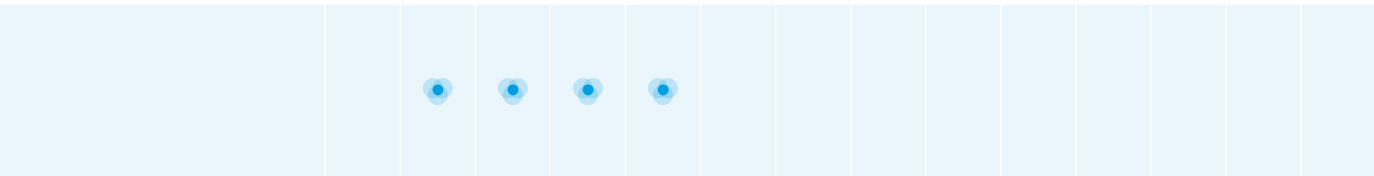
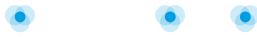
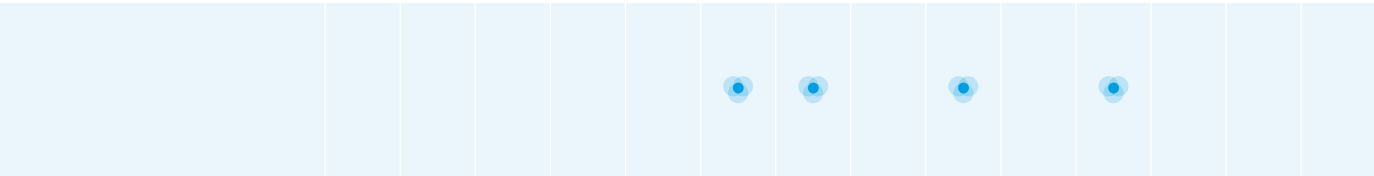
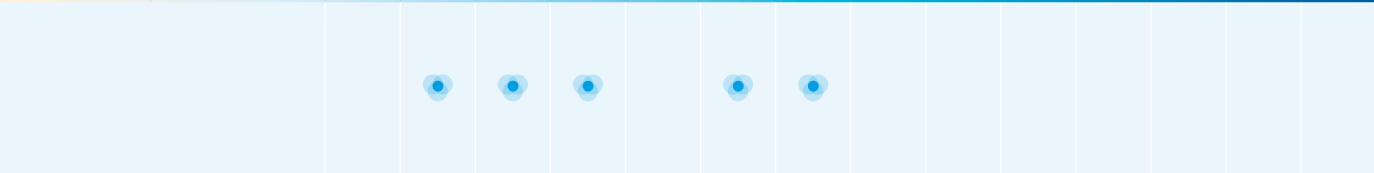

Why choosing a VRF system?



■ One system for multiple applications



Shopping centers



Villas



Hostels



Offices

■ Extrem versatility

- All seasons
- Immediate change mode (heat/cool)
- Extendable system
- Any indoor unit
- Anti-corrosive treatment on demand

Blygold®



HIGH WALL HBV



CASSETTE 600x600 CBV



CASSETTE 900x900 CCV



FLOOR CEILING FAV



DUCTED LOW STATIC PRESSURE DAV



DUCTED MEDIUM STATIC PRESSURE DBV



DUCTED HIGH STATIC PRESSURE DCV



CONSOLE EAV



AHU CONNECTION KIT

■ Easy installation

- Professional selection software
- Easy setup (plumbing, electricity, regulation...)
- Ideal solution for refurbishment (easy installation also in inhabited places)

Why choosing an Airwell VRF?

- Wide range of power: from 3 to 72 HP (from 8 to 240 kW)
- Silent system
- Compact solution: small footprint
- High performance: COP until 4.5
- Certified Eurovent 

Performant system

USE HIGH EFFICIENCY DC INVERTER SCROLL COMPRESSOR, HIGH EFFICACITY, LOW NOISE

The highly efficient Scroll compressor is equipped with a “Framen Compliance Mechanism” that allows movement in the axial direction of the frame supporting the cradle Scroll. This greatly reduces both leakage and friction loss, ensuring very high efficiency throughout the speed range.



HIGH EFFICIENCY DC FAN MOTOR

The speed of wide range DC fan motor can be adjusted from 0 to 1000 tr/min.

Compared to conventional AC motors, a DC fan motor offers greater operating efficiency, especially during low speed rotation. The efficiency could be 90%.



HEAT EXCHANGER ADOPTS THE SUBCOOLING TECHNOLOGY: HIGH EFFICIENCY

- The system is cooled with little refrigerant.
- Improve subcooling degree of refrigerant.
- Avoid energy loss due to refrigerant flash evaporating when it goes through PMV.
- W-model Ø8 innergrooved tube.
- Hydrophilic aluminium coil fin, it will increase efficiency of heat exchange by 5%.

Increase the efficiency of system



- **Increase cooling power by 6%.**
- **Reduce refrigerant circulation amounts.**

PRECISE CONTROL

PID control adjusts the output of compressor and the open degree of EEV, balances the indoor refrigerant flow, realizes the linear output, creates a comfortable environment. The temperature can be controlled precisely.

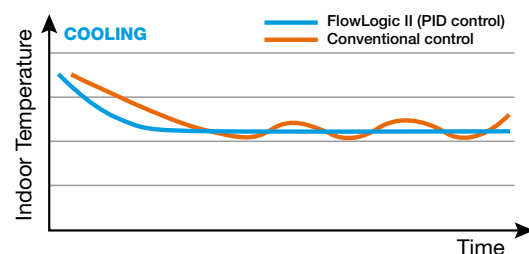



UPGRADE



+ PRODUCTS

- COP can reach 4.2.
- Compact (0.32 m² footprint).
- Easy maintenance.

FEATURES

TECHNOLOGY:



- Capacity range: 3CV, 5 CV, 6 CV and 10 CV.
- Designed for residential use or for light commercial use.
- Minimum outdoor temperature for heating mode operation -15°C.
- Minimum outdoor temperature for cooling mode operation -5°C.
- DC Inverter compressor and ventilator.
- Refrigerant simple pipe length up to 300 m.
- Capacity ratio 50-130%.

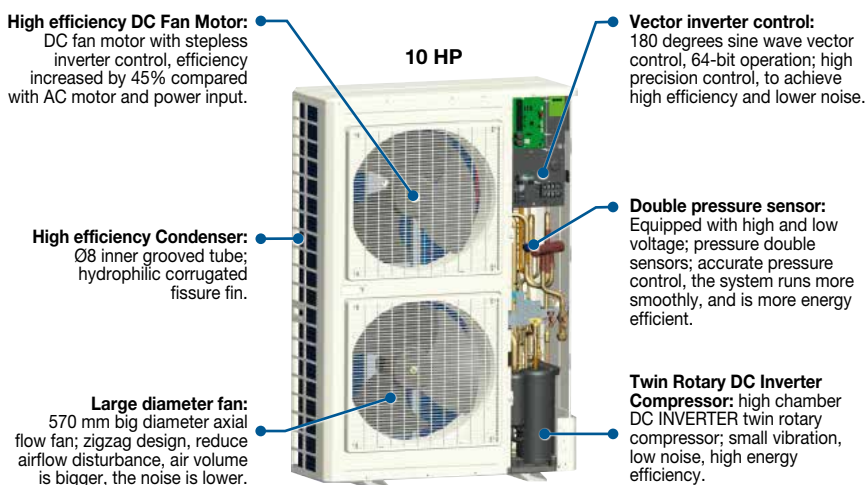
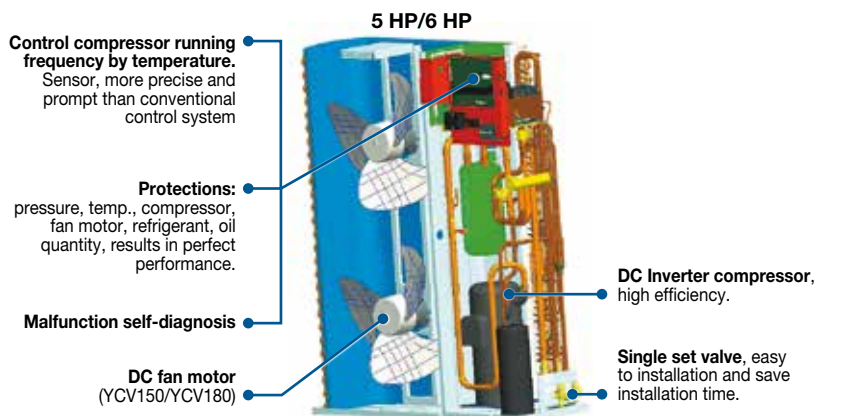

MINI FLOWLOGIC II TECHNICAL DATA

Outdoor units	AWAU-YCV080-H11	Drop only AWAU-YCV125-H11	Drop only AWAU-YCV150-H11	AWAU-YCV150-H13	AWAU-YCV180-H13	AWAU-YCVFD280-H13	
	Phase	Single phase	Single phase	Single phase	Three phases	Three phases	Three phases
Part number	7SP14H045	7SP14H041	7SP14H042	7SP14H044	7SP14H043	7SP14H011	
RATED POWER							
Cooling	kW	8	12.5	15	15	18	28
EER		3.64	3.79	3.77	3.77	3.47	3.5
Seasonal energy efficiency		210			202	181	274
Heating	kW	9.5	14	17	17	20	31.5
COP		4.31	4.12	4.35	4.35	3.9	4.2
Seasonal energy efficiency		144			137	133	199
ELECTRICAL PARAMETERS							
Phase/Tension/Frequency		1P/220-240/50-60Hz/N			3P/400V/50Hz/N		
Cooling rated power input	kW	2.20	3.30	3.98	3.98	5.19	8
Heating rated power input	kW	2.20	3.40	3.91	3.91	5.13	7.5
Max. current	A	18.9	34.1	34.1	11.2	11.6	23.8
PERFORMANCE							
Air flow (HS)	m ³ /h	3500	6500	6500	6500	6500	10000
Sound pressure level (HS)	dB(A)	54	57	58	58	59	
Sound power level (HS)	dB(A)	65	68	69	69	70	58
INSTALLATION							
External dimensions (WxHxD)	mm	960x830x340	960x1250x340	960x1250x340	960x1250x340	960x1250x340	1050x1636x400
Shipping dimensions (WxHxD)	mm	1095x945x410	1095x1400x410	1095x1400x410	1095x1400x410	1095x1400x410	1150x1790x510
Net weight/Gross weight	kg	70/76	99/107	99/107	99/107	99/107	168/183
Compressor type		Rotary	Rotary	Rotary	Rotary	Rotary	Scroll
Liquid pipe diameter	inches	3/8"	3/8"	3/8"	3/8"	3/8"	1/2"
Suction pipe diameter	inches	5/8"	3/4"	3/4"	3/4"	3/4"	7/8"
Max. pipe length	m	100	150	150	150	150	300
Max. height between indoor and outdoor units*	m	30	30	30	30	30	50
Maximum indoor units connectable	quantity	4	8	8	8	9	16
OPERATING LIMITS							
Cooling	°C	10°/48°	-5°/48°	-5°/48°	-5°/48°	-5°/48°	-5°/43°
Heating	°C	-15°/21°	-15°/21°	-15°/21°	-15°/21°	-15°/21°	-15°/21°
PIPE LINE							
Refrigerant / GWP		R410A/2088	R410A/2088	R410A/2088	R410A/2088	R410A/2088	R410A/2088
Charge (0 m)	kg	2.4	3.8	3.8	3.8	3.8	7.4

* 30 m if the outdoor unit is above indoor unit, 20 m if the outdoor unit is below indoor unit.

TUBING ACCESSORIES

Accessory	Part number	Code	Photo	Function	Comments
Manifold pipe (gas + liquid)	7ACFHH001	TAU335		Refrigerant gathering	33.5 kW > Total indoor units power
	7ACFHH002	TAU506		Refrigerant gathering	33.5 kW ≤ Total indoor units power < 50.6 kW
	7ACFHH003	TAU730		Refrigerant gathering	50.6 kW ≤ Total indoor units power < 73 kW
	7ACFHH004	TAU1350		Refrigerant gathering	73 kW ≤ Total indoor units power < 135 kW
	7ACFHH015	TAU2040		Refrigerant gathering	135 kW ≤ Total indoor units power



+ PRODUCTS

- COP can reach 4.45.
- Compact (0.97 m² footprint).
- Large capacity range (single and combination).
- DC Inverter compressor and ventilator.

FEATURES

TECHNOLOGY:



- Capacity range from 10 HP to 72 HP.
- Capacity range until 24 HP with only one unit.
- Designed for all commercial uses.
- Minimum outdoor temperature for heating mode operation -23°C.
- Minimum outdoor temperature for cooling mode operation -5°C.
- Refrigerant simple pipe length up to 1000 m.
- Capacity ratio 50-130%.
- Certified Eurovent.



TUBING ACCESSORIES

Accessory	Part number	Code	Photo	Function	Comments
Gather pipe kit for 2 outdoor groups	7ACFHH013	TBS20		Refrigerant gathering	For 2 outdoor groups
Gather pipe kit for 3 outdoor groups	7ACFHH014	TBS30		Refrigerant gathering	For 3 outdoor groups
Manifold pipe (gas + liquid)	7ACFHH001	TAU335		Refrigerant gathering	33.5 kW > Total indoor units power
	7ACFHH002	TAU506		Refrigerant gathering	33.5 kW ≤ Total indoor units power < 50.6 kW
	7ACFHH003	TAU730		Refrigerant gathering	50.6 kW ≤ Total indoor units power < 73 kW
	7ACFHH004	TAU1350		Refrigerant gathering	73 kW ≤ Total indoor units power < 135 kW
	7ACFHH015	TAU2040		Refrigerant gathering	135 kW ≤ Total indoor units power

HIGH MODULARITY: LONG PIPE LENGTH, HIGH HEIGHT DROP

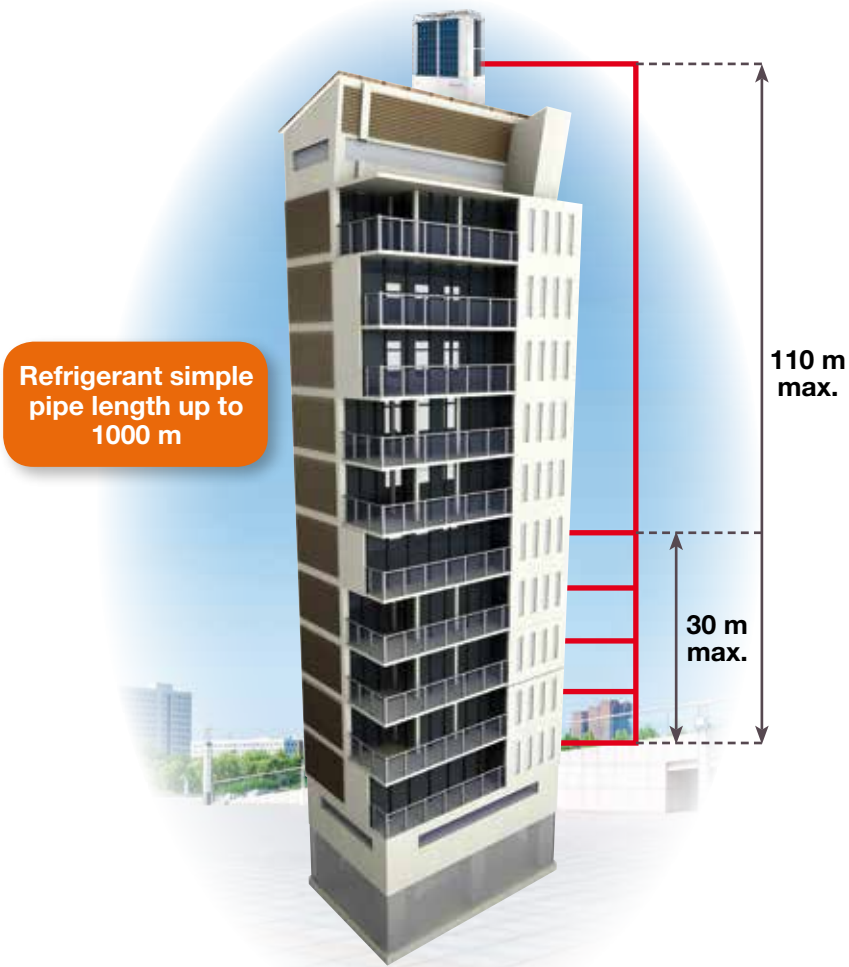

- Floor area optimized for all the product range (same foot print for all modules: 0.97 m²)
- One of the smallest footprint on market.

- Full DC inverter
- 2 x Full DC Inverter



→ 0.97 m²



■ **High static pressure outdoor unit:**
82 Pa, long air duct



Hidden solution:
Installation of
outdoor unit in a
technical room

■ **Wide operation range**

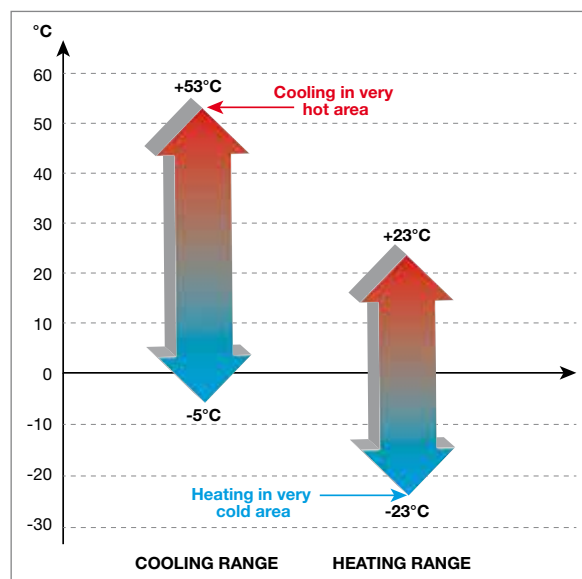

→ **Specific design:**

- Double EEV
- Two-piece condenser
- Independent electrical box

→ **Reliability/Maintenance:**

- Compressor double protection: Two pressure sensors
- Double oil temperature sensor
- Large volume gas-liquid separator (26L) + liquid storage tank (10L)
- Two floor structure (no air bypass during maintenance): efficient measures

→ **Fan:**

- Optimized fan to reduce air vibration
- DC fan to optimize efficiency
- 82 Pa static pressure

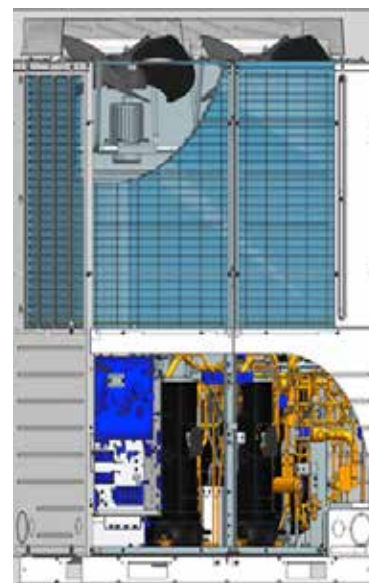

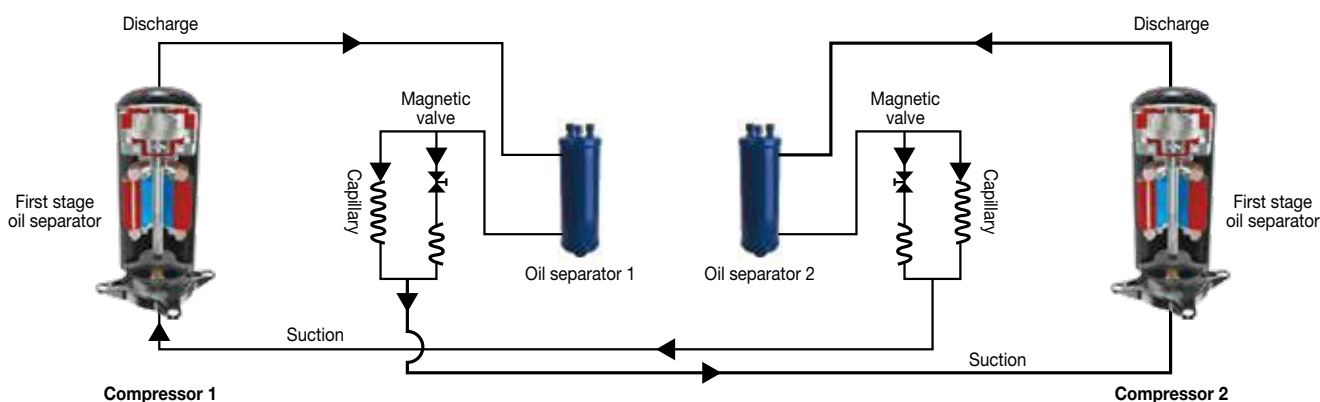

■ **Specific oil return**

- Magnetic valve
- If the compressor operate at low frequency, oil return is only with capillary.
- If the compressor operate at higher frequency, PCB control magnetic valve to improve oil return.



FLOWLOGIC III TECHNICAL DATA

Outdoor units	Drop only				Drop only			
	AWAU-YDV280-H13	AWAU-YDV335-H13	AWAU-YDV400-H13	AWAU-YDV450-H13	AWAU-YDV504-H13	AWAU-YDV560-H13	AWAU-YDV615-H13	AWAU-YDV680-H13
Phase	Three phases	Three phases	Three phases	Three phases	Three phases	Three phases	Three phases	Three phases
Part number	7SP14H030	7HP14H031	7SP14H032	7SP14H033	7SP14H034	7SP14H035	7SP14H036	7SP14H037
								

POWERS

	HP	10	12	14	16	18	20	22	24
Capacity range									
Cooling	kW	28	33.5	40	45	50.4	56	61.5	68
Heating	kW	31.5	37.5	45	50	56.5	63	69	73

ELECTRICAL PARAMETERS

Phase/Tension/Frequency		3P/380-400V/50-60Hz/N								
Cooling	Rated power input	kW	7.00	8.59	10.26	11.90	13.62	15.56	17.57	19.71
	Power input max.	kW	14.38	14.73	16.91	22.68	22.10	25.19	30.56	37.47
	Rated current	A	11.56	14.19	16.94	19.66	22.50	25.69	29.02	32.55
	Current max.	A	23.68	25.1	28.40	36.80	36.15	41.10	49.65	60.65
Heating	Rated power input	kW	7.08	8.72	10.71	12.05	13.95	15.95	18.16	19.47
	Power input max.	kW	13.23	13.68	15.60	17.20	22.68	25.19	27.72	28.62
	Rated current	A	11.69	14.40	17.69	19.90	23.04	26.34	29.99	32.15
	Current max.	A	21.79	22.1	25.20	27.88	37.80	42.00	46.05	47.40
EER		4.00	3.90	3.90	3.78	3.70	3.60	3.50	3.45	
Efficacité énergétique saisonnière		274	269	255	236	242	233	229	223	
COP		4.45	4.30	4.20	4.15	4.05	3.95	3.80	3.75	
Efficacité énergétique saisonnière		199	193	185	163	165	163	154	149	

PERFORMANCE

Airflow	Heating	m³/h	15000	15000	15000	15600	16200	16200	16200	16200
	Cooling	m³/h	13200	13200	13200	14400	15000	15000	15000	15000
Sound pressure level to 1 m		dB(A)	57	59	59.5	61	62	62	62	63
Sound power level		dB(A)	73	75	76	77	79	79	79	80

INSTALLATION

Dimensions (WxHxD)		mm	1350x1690x720	1350x1690x720	1350x1690x720	1350x1690x720	1350x2048x720	1350x2048x720	1350x2048x720	1350x2048x720
Refrigerant / GWP			R410A/2088							
Refrigerant charge		kg	9.7	9.7	10	10	10	10	10	10
Net weight/Gross weight		kg	276/301	276/301	279/304	321/346	335/360	335/360	359/384	359/384
Compressor type			Scroll	Scroll	Scroll	Scroll	Scroll	Scroll	Scroll	Scroll
Tubing	Liquid pipe diameter	inches	3/8"	1/2"	1/2"	1/2"	5/8"	5/8"	5/8"	5/8"
	Suction pipe diameter	inches	7/8"	1"	1"	1 1/8"	1 1/8"	1 1/8"	1 1/8"	1 1/8"
	Oil equalization pipe	inches	3/8"	3/8"	3/8"	3/8"	3/8"	3/8"	3/8"	3/8"
	Max. tube length	meter	1000	1000	1000	1000	1000	1000	1000	1000
Max. height between indoor and outdoor units (ODU up/down)		m	50/40	50/40	50/40	50/40	50/40	50/40	50/40	50/40
Max. height between indoor units		m	18	18	18	18	18	18	18	18
External static pressure		Pa	82	82	82	82	82	82	82	82
Environment temperature range	Cooling	°C	-5°/50°							
	Heating	°C	-23°/21°							
Maximum indoor units connectable		quantity	20	24	29	33	37	41	45	49



TECHNICAL DATA FOR 14, 16, 18 & 20 HP TWO COMBINATIONS

		Drop only						
Outdoor units		YDV735-H13	YDV800-H13	YDV850-H13	YDV904-H13	YDV950-H13	YDV1010	
Phase		Three phases	Three phases	Three phases	Three phases	Three phases	Three phases	
Combinations part number		YDV335/ 7SP14H031	YDV400/ 7SP14H032	YDV400/ 7SP14H032	YDV400/ 7SP14H032	YDV450/ 7SP14H033	YDV450/ 7SP14H033	
		YDV400/ 7SP14H032	YDV400/ 7SP14H032	YDV450/ 7SP14H033	YDV504/ 7SP14H034	YDV560/ 7SP14H034	YDV560/ 7SP14H035	
POWERS								
Capacity range	HP	26	28	30	32	34	36	
Cooling	kW	73.5	80	85	90.4	95.4	101	
Heating	kW	82.5	90	95	101.5	106.5	113	
ELECTRICAL PARAMETERS								
Phase/Tension/Frequency		3P/380-400V/50-60Hz/N						
Cooling	Rated power input	kW	18.85	20.51	22.16	23.88	25.53	27.46
	Power input max.	kW	31.64	33.81	39.59	39.00	44.78	47.87
	Rated current	A	31.12	33.88	36.60	39.43	42.16	45.35
	Current max.	A	53.5	56.80	65.20	64.55	72.95	77.90
Heating	Rated power input	kW	19.44	21.43	22.76	24.66	26.00	28.00
	Power input max.	kW	29.28	31.20	32.80	38.28	39.88	42.39
	Rated current	A	32.10	35.39	37.59	40.73	42.94	46.24
	Current max.	A	47.3	50.40	53.08	63.00	65.68	69.88
EER			3.90	3.90	3.84	3.79	3.74	3.68
COP			4.24	4.20	4.17	4.12	4.10	4.04
PERFORMANCE								
Airflow	Heating	m³/h	30000	30000	30600	31200	31480	31480
	Cooling	m³/h	26400	26400	27600	28200	29400	29400
Sound pressure level to 1 m		dB(A)	62	62.5	63	64	64.5	64.5
Sound power level		dB(A)	79	80	80	81	82	82
INSTALLATION								
Dimensions (WxHxD)		mm	(1350x1690x720)x2	(1350x1690x720) x2	(1350x1690x720) x2	1350x1690x720 + 1350x2048x720	1350x1690x720 + 1350x2048x720	1350x1690x720 + 1350x2048x720
Refrigerant / GWP			R410A/2088					
Refrigerant charge		kg	10+10	10+10	10+10	10+10	10+10	10+10
Net weight/Gross weight		kg	276/301 + 279/304	279/304 + 279/304	279/304 + 321/346	321/346 + 335/360	321/346 + 335/360	321/346 + 335/360
Compressor type			Scroll	Scroll	Scroll	Scroll	Scroll	Scroll
Tubing	Liquid pipe diameter	inches	3/4"	3/4"	3/4"	3/4"	3/4"	3/4"
	Suction pipe diameter	inches	1"1/4	1"1/4	1"1/4	1"1/4	1"1/4	1"1/4
	Oil equalization pipe	inches	3/8"	3/8"	3/8"	3/8"	3/8"	3/8"
	Max. tube length	meter	1000	1000	1000	1000	1000	1000
Max. height between indoor and outdoor units (ODU up/down)		m	50/40	50/40	50/40	50/40	50/40	50/40
Max. height between indoor units		m	18	18	18	18	18	18
External static pressure		Pa	82	82	82	82	82	82
Environment temperature range	Cooling	°C	-5°/50°					
	Heating	°C	-23°/21°					
Maximum indoor units connectable		quantity	53	58	62	64	64	64



TECHNICAL DATA FOR 18, 20 & 24 HP TWO COMBINATIONS

Outdoor units	Drop only			Drop only		
	YDV1064-H13	YDV1120-H13	YDV1175-H13	YDV1240-H13	YDV1295-H13	YDV1360-H13
Phase	Three phases	Three phases	Three phases	Three phases	Three phases	Three phases
Combinations part number	YDV504/ 7SP14H034	YDV560/ 7SP14H035	YDV560/ 7SP14H035	YDV560/ 7SP14H035	YDV615/ 7SP14H036	YDV680/ 7SP14H037
	YDV560/ 7SP14H035	YDV560/ 7SP14H035	YDV615/ 7SP14H036	YDV680/ 7SP14H037	YDV680/ 7SP14H037	YDV680/ 7SP14H037



POWERS							
Capacity range	HP	38	40	42	44	46	48
Cooling	kW	106.4	112	117.5	124	129.5	136
Heating	kW	119.5	126	132	136	142	146

ELECTRICAL PARAMETERS								
Phase/Tension/Frequency		3P/380-400V/50-60Hz/N						
Cooling	Rated power input	kW	29.18	31.11	33.13	35.27	37.28	39.42
	Power input max.	kW	47.28	50.37	55.75	62.66	68.03	74.94
	Rated current	A	48.19	51.38	54.71	58.24	61.57	65.10
	Current max.	A	77.25	82.20	90.75	101.55	110.1	120.90
Heating	Rated power input	kW	29.90	31.90	34.11	35.42	37.62	38.93
	Power input max.	kW	47.87	50.37	52.91	53.81	56.34	57.24
	Rated current	A	49.38	52.68	56.33	58.49	62.14	64.30
	Current max.	A	19.80	84.00	88.05	89.40	93.45	94.80
EER		3.65	3.60	3.55	3.52	3.47	3.45	
COP		4.00	3.95	3.87	3.84	3.77	3.75	

PERFORMANCE								
Airflow	Heating	m³/h	32400	32400	32400	32400	32400	32400
	Cooling	m³/h	30000	30000	30000	30000	30000	30000
Sound pressure level to 1 m		dB(A)	65	65	65	65.5	65.5	66
Sound power level		dB(A)	83	83	83	83	83	84

INSTALLATION								
Dimensions (WxHxD)		mm	(1350x2048x720) x2	(1350x2048x720) x2	(1350x2048x720) x2	(1350x2048x720) x2	(1350x2048x720) x2	(1350x2048x720) x2
Refrigerant / GWP		R410A/2088						
Refrigerant charge		kg	10+10	10+10	10+10	10+10	10+10	10+10
Net weight/Gross weight		kg	(335/360)x2	(335/360)x2	335/360 + 359/384	335/360 + 359/384	(359/384)x2	359/384 + 359/384
Compressor type			Scroll	Scroll	Scroll	Scroll	Scroll	Scroll
Tubing	Liquid pipe diameter	inches	3/4"	3/4"	3/4"	3/4"	3/4"	3/4"
	Suction pipe diameter	inches	1"1/4	1"1/4	1"1/4	1"1/4	1"1/4	1"1/4
	Oil equalization pipe	inches	3/8"	3/8"	3/8"	3/8"	3/8"	3/8"
	Max. tube length	meter	1000	1000	1000	1000	1000	1000
Max. height between indoor and outdoor units (ODU up/down)		m	50/40	50/40	50/40	50/40	50/40	50/40
Max. height between indoor units		m	18	18	18	18	18	18
External static pressure		Pa	82	82	82	82	82	82
Environment temperature range	Cooling	°C	-5°/50°					
	Heating	°C	-23°/21°					
Maximum indoor units connectable		quantity	64	64	64	64	64	64



TECHNICAL DATA FOR 14, 16, 18 & 20 HP THREE COMBINATIONS

Outdoor units		YDV1408-H13	YDV14602-H13	YDV1514-H13	YDV1570-H13	
Phase		Three phases	Three phases	Three phases	Three phases	
Combinations part number		YDV400/7SP14H032	YDV450/7SP14H033	YDV450/7SP14H033	YDV450/7SP14H033	
		YDV504/7SP14H034	YDV450/7SP14H033	YDV504/7SP14H034	YDV560/7SP14H035	
		YDV504/7SP14H034	YDV560/7SP14H035	YDV560/7SP14H035	YDV560/7SP14H035	
						
POWERS						
Capacity range	HP	50	52	54	56	
Cooling	kW	140.8	146	151.4	157	
Heating	kW	158	163	169.5	176	
ELECTRICAL PARAMETERS						
Phase/Tension/Frequency		3P/380-400V/50-60Hz/N				
Cooling	Rated power input	kW	37.50	39.37	41.08	43.02
	Power input max.	kW	61.10	70.55	69.96	73.05
	Rated current	A	61.93	65.01	67.85	71.04
	Current max.	A	100.70	114.70	114.05	119.00
Heating	Rated power input	kW	38.62	40.05	41.95	43.95
	Power input max.	kW	60.96	59.59	65.07	67.57
	Rated current	A	63.77	66.14	69.28	72.58
	Current max.	A	100.80	97.76	107.68	111.88
EER		3.75	3.71	3.69	3.65	
COP		4.09	4.07	4.04	4.00	
PERFORMANCE						
Airflow	Heating	m³/h	44440	44440	48000	48000
	Cooling	m³/h	43200	43480	44440	44440
Sound pressure level to 1 m		dB(A)	66	66	66.5	66.5
Sound power level		dB(A)	84	84	85	85
INSTALLATION						
Dimensions (WxHxD)		mm	1350x1690x720 + (1350x2048x720)x2	1350x1690x720 + (1350x2048x720)x2	1350x1690x720 + (1350x2048x720)x2	1350x1690x720 + (1350x2048x720)x2
Refrigerant / GWP			R410A/2088			
Refrigerant charge		kg	10+10+10	10+10+10	10+10+10	10+10+10
Net weight/Gross weight		kg	279/304 + (335/360)x2	321/346 + (335/360)x2	321/346 + (335/360)x2	(335/360)x3
Compressor type			Scroll	Scroll	Scroll	Scroll
Tubing	Liquid pipe diameter	inches	3/4"	3/4"	3/4"	3/4"
	Suction pipe diameter	inches	1"1/2	1"1/2	1"1/2	1"5/8
	Oil equalization pipe	inches	3/8"	3/8"	3/8"	3/8"
	Max. tube length	meter	1000	1000	1000	1000
Max. height between indoor and outdoor units (ODU up/down)		m	50/40	50/40	50/40	50/40
Max. height between indoor units		m	18	18	18	18
External static pressure		Pa	82	82	82	82
Environment temperature range	Cooling	°C	-5°/50°			
	Heating	°C	-23°/21°			
Maximum indoor units connectable		quantity	64	64	64	64

TECHNICAL DATA FOR 18, 20 & 24 HP THREE COMBINATIONS

Outdoor units		YDV1624-H13	YDV1680-H13	Drop only YDV1735-H13	YD V1800-H13	
Phase		Three phases	Three phases	Three phases	Three phases	
Combinations part number		YDV504/7SP14H034	YDV560/7SP14H035	YDV560/7SP14H035	YDV560/7SP14H035	
		YDV560/7SP14H035	YDV560/7SP14H035	YDV560/7SP14H035	YDV560/7SP14H035	
		YDV560/7SP14H035	YDV560/7SP14H035	YDV615/7SP14H036	YDV680/7SP14H037	
POWERS						
Capacity range	HP	58	60	62	64	
Cooling	kW	162.4	168	173,5	180	
Heating	kW	182.5	189	195	199	
ELECTRICAL PARAMETERS						
Phase/Tension/Frequency		3P/380-400V/50-60Hz/N				
Cooling	Rated power input	kW	44.73	46.67	48,68	50.82
	Power input max.	kW	72.47	75.56	80,93	87.84
	Rated current	A	73.88	77.07	80,40	83.93
	Current max.	A	118.35	123.30	131,85	142.65
Heating	Rated power input	kW	45.85	47.85	50,06	51.37
	Power input max.	kW	73.05	75.56	78,09	78.99
	Rated current	A	75.72	79.02	82,67	84.83
	Current max.	A	121.80	126.00	130,05	131.40
EER		3.63	3.60	3,56	3.54	
COP		3.98	3.95	3,90	3.87	
PERFORMANCE						
Airflow	Heating	m³/h	48600	48600	48600	48600
	Cooling	m³/h	45000	45000	45000	45000
Sound pressure level to 1 m		dB(A)	67	67	67	67
Sound power level		dB(A)	85	85	85	85
INSTALLATION						
Dimensions (WxHxD)	mm	(1350x2048x720) x 3	(1350x2048x720) x 3	(1350x2048x720) x 2 + (1350x2048x720)	(1350x2048x720) x 3	
Refrigerant / GWP		R410A/2088				
Refrigerant charge	kg	10+10+10	10+10+10	10+10+10	10+10+10	
Net weight/Gross weight	kg	(335/360)x3	(335/360)x3	(335/360)x2 + (359/384)	(335/360)x2 + 359/384	
Compressor type		Scroll	Scroll	Scroll	Scroll	
Tubing	Liquid pipe diameter	inches	3/4"	3/4"	3/4"	3/4"
	Suction pipe diameter	inches	1"5/8	1"5/8	1"5/8	1"5/8
	Oil equalization pipe	inches	3/8"	3/8"	3/8"	3/8"
	Max. tube length	meter	1000	1000	1000	1000
Max. height between indoor and outdoor units (ODU up/down)	m	50/40	50/40	50/40	50/40	
Max. height between indoor units	m	18	18	18	18	
External static pressure	Pa	82	82	82	82	
Environment temperature range	Cooling	°C	-5°/50°			
	Heating	°C	-23°/21°			
Maximum indoor units connectable	quantity	64	64	64	64	



TECHNICAL DATA FOR 20 & 24 HP THREE COMBINATIONS

Outdoor units	Drop only		Drop only	
	YDV1855-H13	YDV1920-H13	YDV1975-H13	YDV2040-H13
Phase	Three phases	Three phases	Three phases	Three phases
Combinations part number	YDV560/7SP14H035	YDV560/7SP14H035	YDV615/7SP14H036	YDV680/7SP14H037
	YDV615/7SP14H036	YDV680/7SP14H037	YDV680/7SP14H037	YDV680/7SP14H037
	YDV680/7SP14H037	YDV680/7SP14H037	YDV680/7SP14H037	YDV680/7SP14H037



POWERS

	HP	66	68	70	72
Capacity range					
Cooling	kW	185.5	192	197.5	204
Heating	kW	205	209	215	219

ELECTRICAL PARAMETERS

Phase/Tension/Frequency		3P/380-400V/50-60Hz/N				
Cooling	Rated power input	kW	52.84	54.98	56.99	59.13
	Power input max.	kW	93.22	100.13	105.50	112.41
	Rated current	A	87.26	90.79	94.12	97.65
	Current max.	A	151.2	162.00	170.55	181.35
Heating	Rated power input	kW	53.57	54.88	57.09	58.40
	Power input max.	kW	81.53	82.43	84.96	85.86
	Rated current	A	88.48	90.64	94.29	96.45
	Current max.	A	135.45	136.80	140.85	142.20
EER			3.51	3.49	3.47	3.45
COP			3.83	3.81	3.77	3.75

PERFORMANCE

Airflow	Heating	m³/h	48600	48600	48600	48600
	Cooling	m³/h	45000	45000	45000	45000
Sound pressure level to 1 m		dB(A)	67	67.5	67.5	67.5
Sound power level		dB(A)	85	86	86	86

INSTALLATION

Dimensions (WxHxD)		mm	(1350x2048x720) x 3	(1350x2048x720) x 3	(1350x2048x720) x 3	(1350x2048x720) x 3
Refrigerant / GWP			R410A/2088			
Refrigerant charge		kg	10+10+10	10+10+10	10+10+10	10+10+10
Net weight/Gross weight		kg	(335/360)x2 + 359/384	335/360 + (359/384)x2	335/360 + (359/384)x2	335/360 + (359/384)x2
Compressor type			Scroll	Scroll	Scroll	Scroll
Tubing	Liquid pipe diameter	inches	7/8"	7/8"	7/8"	7/8"
	Suction pipe diameter	inches	1"3/4	1"3/4	1"3/4	1"3/4
	Oil equalization pipe	inches	3/8"	3/8"	3/8"	3/8"
	Max. tube length	meter	1000	1000	1000	1000
Max. height between indoor and outdoor units (ODU up/down)		m	50/40	50/40	50/40	50/40
Max. height between indoor units		m	18	18	18	18
External static pressure		Pa	82	82	82	82
Environment temperature range	Cooling	°C	-5°/50°			
	Heating	°C	-23°/21°			
Maximum indoor units connectable		quantity	64	64	64	64

A series of horizontal dotted lines for writing.



NEW



+ PRODUCTS

- Heat recovery.
- COP can reach 4.10.
- Wide capacity range.
- Silent mode: -8 dB(A).

FEATURES

TECHNOLOGY:



R410A FLUID



DC INVERTER



- Simultaneous operation in heating and cooling mode.
- Capacity range from 10 HP to 48 HP.
- Up to 64 indoor connectable units.
- DC inverter fan.
- Capacity ratio 50-130%.
- Minimum outdoor temperature for heating operation -15°C.
- Minimum outdoor temperature for cooling operation -5°C.
- Same indoor units and control devices across Mini FlowLogic II and FlowLogic III ranges (except EAV console range).
- Optimized dimensions, can be transported by elevator.
- Operation with time equalization (for twinned groups).
- Wide range of control systems.

3-PIPES VRF RANGE SPECIFIC ACCESSORIES

Accessory	Part number	Photo	Description
TAS 20 HR	7ACFHH011		Gather Pipe 3 pipes
TAS 30 HR	7ACFHH012		Gather Pipe 3 pipes
TAU 335 HR	7ACFHH007		Manifold pipe for capacity less than 33.5 kW
TAU 506 HR	7ACFHH008		Manifold pipe for capacity less than 50.6 kW
TAU 730 HR	7ACFHH009		Manifold pipe for capacity less than 73.0 kW
TAU 1350 HR	7ACFHH010		Manifold pipe for capacity less than 135.0 kW
Valve Box	7ACELH017		kit HR under 11.2 kW
Valve Box	7ACELH018		Kit HR 11.2 kW - 18 kW
Valve Box	7ACELH019		Kit HR above 18 kW

Voir les accessoires généraux en page 134.

OPERATION PRINCIPLE OF THE HEAT RECOVERY SYSTEM

- Simultaneous operation in hot and cold.
- Overall optimization of the efficiency of the system by heat transfer between the rooms to be heated and cooled.
- Reactive during a change of operating mode (heating / cooling).

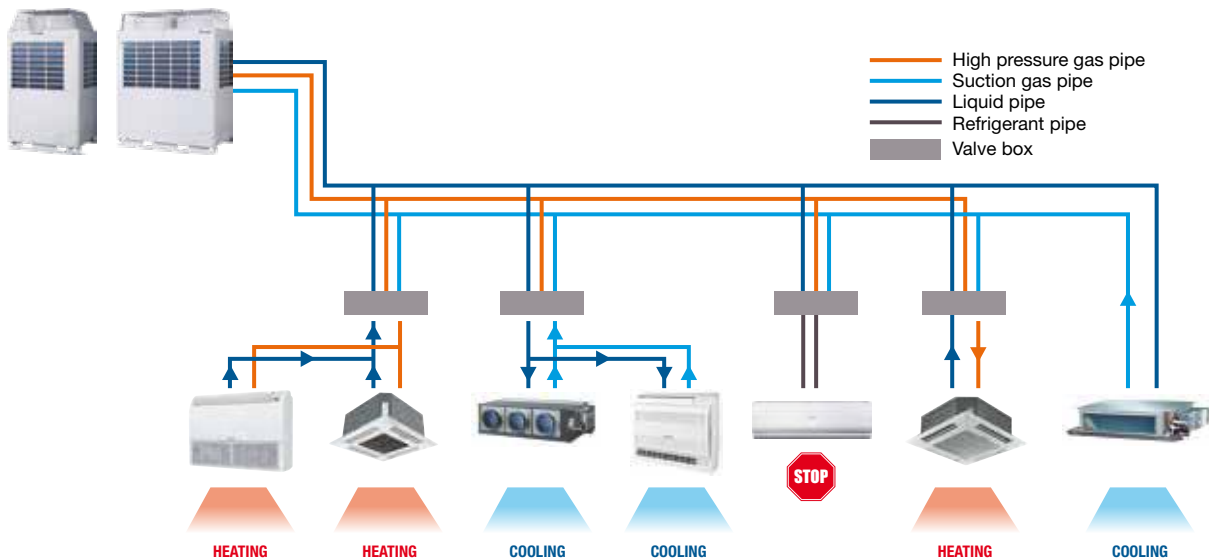

HIGH PERFORMANCE

- Optimized operation at partial load: two-part condenser with independent control (double electronic expander).
- DC Inverter compressor (1 additional fixed speed compressor from 12CV).
- Powerful DC fan (low noise level and energy savings).
- Wide operating range.

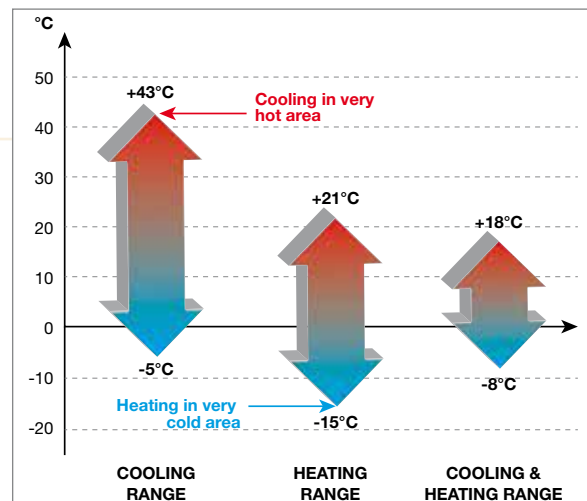

EASY INSTALLATION

- Accessible cooling network, regardless of the electronic part.
- Ducted unit: possible installation indoors (Static pressure 50Pa).

**Hidden solution:
Installation of
outdoor unit in a
technical room**





FLOWLOGIC II HR

3-PIPES TOP DISCHARGE

Capacity (HP)	Cooling power (kW)	Heating power (kW)	OUTDOOR UNITS	INDOOR UNITS	
			Combinations FlowLogic II HR	Maximum indoor units connectable	Range cooling power connectable* (kW)
10	28	31.5	1 X YCV280HR	16	14 - 36
12	33.5	37.5	1 X YCV335HR	19	17 - 43
14	40	45	1 X YCV400HR	23	20 - 52
16	45	50	1 X YCV450HR	26	22.5 - 58.5
20	56	63	2 X YCV280HR	33	28 - 72
22	61.5	69	1 X YCV280HR + 1 X YCV335HR	36	31 - 79.5
24	68	76.5	1 X YCV280HR + 1 X YCV400HR	39	34 - 88
26	73	81.5	1 X YCV280HR + 1 X YCV450HR	43	37 - 94.5
28	80	87.5	2 X YCV400HR	46	40 - 104
30	85	95	1 X YCV400HR + 1 X YCV450HR	50	43 - 110.5
32	90	100	2 X YCV450HR	53	45 - 117
34	96	108	2 X YCV280HR + 1 X YCV400HR	56	48 - 124.5
36	101	113	2 X YCV280HR + 1 X YCV450HR	59	51 - 131
38	108	119	1 X YCV280HR + 2 X YCV400HR	63	54 - 140
40	113	126.5	1 X YCV280HR + 1 X YCV400HR + 1 X YCV450HR	64	57 - 146.5
42	118	131.5	1 X YCV280HR + 2 X YCV450HR	64	59 - 153
44	123.5	137.5	1 X YCV335HR + 2 X YCV450HR	64	62 - 160.5
46	130	145	1 X YCV400HR + 2 X YCV450HR	64	65 - 169
48	135	150	3 X YCV450HR	64	68 - 175.5



* Indoor total capacity can be 50% - 130% of outdoor capacity.

FLOWLOGIC II HR TECHNICAL DATA

Outdoor units		AWAU-YCV280HR-H13	AWAU-YCV335HR-H13	AWAU-YCV400HR-H13	AWAU-YCV450HR-H13
Phase		Three phases	Three phases	Three phases	Three phases
Part number		7SP14H016	7SP14H019	7SP14H017	7SP14H018
					
RATED POWER					
Cooling	kW	28	33.5	40	45
Heating	kW	28	37.5	45	50
ELECTRICAL PARAMETERS					
Phase/Tension/Frequency		3P/380-400V/50-60Hz/N			
Cooling rated power input	kW	3.71	9.18	12.3	14.1
Heating rated power input	kW	7.55	9.15	11.1	13.5
EER/COP		3.71/3.95	3.65/4.10	3.25/4.05	3.20/3.70
Max. current	A	23.4	27.9	29.5	32.37
PERFORMANCE					
Airflow (HS)	m³/h	11100	14100	14100	14100
Noise level (HS)	dB(A)	57	60	60	60
INSTALLATION					
External dimensions (WxHxD)	mm	990x1808x750	1390x1808x750	1390x1808x750	1390x1808x750
Shipping dimensions (WxHxD)	mm	1090x1990x860	1490x1990x860	1490x1990x860	1490x1990x860
Net weight/Gross weight	kg	240/268	368/393	368/393	368/393
Compressor type		Scroll DC Inverter	Scroll DC Inverter	Scroll DC Inverter	Scroll DC Inverter
Liquid pipe diameter	inches	3/8"	1/2"	1/2"	1/2"
Suction pipe diameter	inches	7/8"	1"	1"	1"1/8"
Max. pipe length	m	175	175	175	175
Max. height between indoor and outdoor units*	m	50/40	50/40	50/40	50/40
Max. height between indoor units	m	15	15	15	15
Maximum indoor units connectable	quantity	16	19	23	26
OPERATING LIMITS					
Cooling	°C	-5°/43° Dry bulb			
Heating	°C	-15°/21° Dry bulb			
PIPE LINE					
Refrigerant / GWP		R410A	R410A	R410A	R410A
Charge	kg	10	10	10	10

* 30 m if the outdoor unit is above indoor unit, 20 m if the outdoor unit is below indoor unit.

TECHNICAL DATA FOR TWO COMBINATIONS

Indoor units		YCV560HR-H13	YCV615HR-H13	YCV680HR-H13	YCV730HR-H13	
Phase		Three phases	Three phases	Three phases	Three phases	
Part number		YCV280HR/7SP14H016	YCV280HR/7SP14H016	YCV280HR/7SP14H016	YCV280HR/7SP14H016	
		YCV280HR/7SP14H016	YCV335HR/7SP14H019	YCV400HR/7SP14H017	YCV450HR/7SP14H018	
						
RATED POWER						
Capacity range	CV	20	22	24	26	
Cooling	kW	56	61.5	68	73	
Heating	kW	63	69	76.5	81.5	
ELECTRICAL PARAMETERS						
Phase/Tension/Frequency		3P/380-400V/50-60Hz/N				
Cooling	Rated power input	kW	15.1	16.73	19.85	21.65
	EER		3.71	3.68	3.43	3.37
	Rated current	A	24.67	27.33	32.43	35.37
Heating	Rated power input	kW	15.94	17.12	19.07	21.47
	COP		3.95	4.03	4.01	3.80
	Rated current	A	26.04	27.97	31.16	35.08
Power input max.		kW	29.4	32.24	33.25	35.18
Current max.		A	46.8	51.3	52.9	55.77
PERFORMANCE						
Airflow	m³/h	22200	25200	25200	25200	
Sound pressure level to 1 m	dB(A)	60	61	61	61	
INSTALLATION						
Dimensions (WxHxD)	mm	(990x1808x750)*2	990x1808x750 + 1390x1808x750	990x1808x750 + 1390x1808x750	990x1808x750 + 1390x1808x750	
Package dimensions (WxHxD)		(1090x1990x860)*2	1090x1990x860 + 1490x1990x860	1090x1990x860 + 1490x1990x860	1090x1990x860 + 1490x1990x860	
Net weight/Gross weight	kg	480/510	608/641	608/641	608/641	
Refrigerant / GWP		R-410A	R-410A	R-410A	R410A	
Refrigerant charge	kg	20	20	20	20	
Compressor type		Scroll	Scroll	Scroll	Scroll	
Tubing	Liquid pipe diameter	inches	5/8"	5/8"	5/8"	3/4"
	Suction pipe diameter	inches	1"1/8	1"1/8	1"1/4	1"1/4
	Max. tube length	mètre	175	175	175	175
Max. height between indoor and outdoor units (ODU up/down)		m	50/40	50/40	50/40	50/40
Max. height between indoor units		m	15	15	15	15
Environment temperature range	Cooling	°C	-5°/43° Dry bulb			
	Heating	°C	-15°/21° Dry bulb			
Maximum indoor units connectable	quantity	33	36	39	43	

TECHNICAL DATA FOR TWO COMBINATIONS

Indoor units	YCV800HR-H13	YCV850HR-H13	YCV900HR-H13
Phase	Three phases	Three phases	Three phases
Part number	YCV400HR/7SP14H017	YCV400HR/7SP14H017	YCV450HR/7SP14H018
	YCV400HR/7SP14H017	YCV450HR/7SP14H018	YCV450HR/7SP14H018
			

RATED POWER				
Capacité	CV	28	30	32
Puissance frigorifique	kW	80	85	90
Puissance calorifique	kW	90	95	100

ELECTRICAL PARAMETERS					
Phase/Tension/Frequency			3P/380-400V/50-60Hz/N		
Cooling	Rated power input	kW	24.6	26.4	28.2
	EER		3.25	3.22	3.19
	Rated current	A	40.19	43.13	46.07
Heating	Rated power input	kW	22.2	24.6	27
	COP		4.05	3.86	3.70
	Rated current	A	36.27	40.19	44.11
Power input max.		kW	37.1	39.03	40.96
Current max.		A	59	61.87	64.74

PERFORMANCE				
Airflow	m³/h	28200	28200	28200
Sound pressure level to 1 m	dB(A)	62	62	62

INSTALLATION					
Dimensions (WxHxD)		mm	1390x1808x750+1390x1808x750	1390x1808x750+1390x1808x750	(1390x1808x750)*2
Package dimensions (WxHxD)			1490x1990x860+1490x1990x860	1490x1990x860+1490x1990x860	(1490x1990x860)*2
Net weight/Gross weight		kg	736/772	736/772	736/772
Refrigerant / GWP			R-410A	R-410A	R410A
Refrigerant charge		kg	20	20	20
Compressor type			Scroll	Scroll	Scroll
Tubing	Liquid pipe diameter	inches	3/4"	3/4"	3/4"
	Suction pipe diameter	inches	1"1/4	1"1/4	1"1/4
	Max. tube length	mètre	175	175	175
Max. height between indoor and outdoor units (ODU up/down)		m	50/40	50/40	50/40
Max. height between indoor units		m	15	15	15
Environment temperature range	Cooling	°C	-5°/43° Dry bulb		
	Heating	°C	-15°/21° Dry bulb		
Maximum indoor units connectable		quantity	46	50	53

TECHNICAL DATA FOR THREE COMBINATIONS

Indoor units	YCV960HR-H13	YCV1010HR-H13	YCV1080HR-H13	YCV1180HR-H13
Phase	Three phases	Three phases	Three phases	Three phases
Part number	YCV280HR/7SP14H016	YCV280HR/7SP14H016	YCV280HR/7SP14H016	YCV280HR/7SP14H016
	YCV280HR/7SP14H016	YCV280HR/7SP14H016	YCV400HR/7SP14H017	YCV400HR/7SP14H017
	YCV400HR/7SP14H017	YCV450HR/7SP14H018	YCV400HR/7SP14H017	YCV450HR/7SP14H018
				

RATED POWER

Capacité	CV	34	36	38	40
Puissance frigorifique	kW	96	101	108	113
Puissance calorifique	kW	108	113	121.50	126.5

ELECTRICAL PARAMETERS

Phase/Tension/Frequency		3P/380-400V/50-60Hz/N				
Cooling	Rated power input	kW	27.4	29.2	32.15	33.95
	EER		3.50	3.46	3.36	3.33
	Rated current	A	44.76	47.71	52.53	55.47
Heating	Rated power input	kW	27.04	29.44	30.17	32.57
	COP		3.99	3.84	4.03	3.88
	Rated current	A	44.18	48.10	49.29	53.21
Power input max.	kW	47.95	49.88	51.8	53.73	
Current max.	A	76.3	79.17	82.4	85.27	

PERFORMANCE

Airflow	m³/h	39300	36300	39300	39300
Sound pressure level to 1 m	dB(A)	63	63	63	63

INSTALLATION

Dimensions (WxHxD)	mm	990x1808x750*2 + 1390x1808x750	(990x1808x750)*2 + (1390x1808x750)	990x1808x750 + 1390x1808x750 + 1390x1808x750	(990x1808x750) + (1390x1808x750) + (1390x1808x750)
Package dimensions (WxHxD)		1090x1990x860*2 + 1490x1990x860	(1090x1990x860)*2 + (1490x1990x860)	1090x1990x860 + 1490x1990x860 + 1490x1990x860	(1090x1990x860) + (1490x1990x860) + (1490x1990x860)
Net weight/Gross weight	kg	848/896	848/896	976/1027	976/1027
Refrigerant / GWP		R-410A	R-410A	R-410A	R410A
Refrigerant charge	kg	30	30	30	30
Compressor type		Scroll	Scroll	Scroll	Scroll
Tubing	Liquid pipe diameter	inches	3/4"	3/4"	3/4"
	Suction pipe diameter	inches	1"1/4	1"1/4	1"1/4
	Max. tube length	mètre	175	175	175
Max. height between indoor and outdoor units (ODU up/down)	m	50/40	50/40	50/40	50/40
Max. height between indoor units	m	15	15	15	15
Environment temperature range	Cooling	°C	-5°/43° Dry bulb		
	Heating	°C	-15°/21° Dry bulb		
Maximum indoor units connectable	quantity	56	59	63	64

TECHNICAL DATA FOR THREE COMBINATIONS

Indoor units	YCV1180HR-H13	YCV1235HR-H13	YCV1300HR-H13	YCV1350HR-H13
Phase	Three phases	Three phases	Three phases	Three phases
Part number	YCV280HR/7SP14H016	YCV335HR/7SP14H019	YCV400HR/7SP14H017	YCV450HR/7SP14H018
	YCV450HR/7SP14H018	YCV450HR/7SP14H018	YCV450HR/7SP14H018	YCV450HR/7SP14H018
	YCV450HR/7SP14H018	YCV450HR/7SP14H018	YCV450HR/7SP14H018	YCV450HR/7SP14H018
				

RATED POWER

	CV	42	44	46	48
Capacité					
Puissance frigorifique	kW	118	123.5	130	135
Puissance calorifique	kW	131.5	137.5	145	150

ELECTRICAL PARAMETERS

Phase/Tension/Frequency		3P/380-400V/50-60Hz/N				
Cooling	Rated power input	kW	35.75	37.38	40.5	42.3
	EER		3.30	3.30	3.21	3.19
	Rated current	A	58.41	61.07	66.17	69.11
Heating	Rated power input	kW	34.97	36.15	38.1	40.5
	COP		3.76	3.80	3.81	3.70
	Rated current	A	57.13	59.06	62.25	66.17
Power input max.	kW	55.66	58.5	59.51	61.44	
Current max.	A	88.14	92.64	94.24	97.11	

PERFORMANCE

	m³/h	39300	42300	42300	42300
Airflow					
Sound pressure level to 1 m	dB(A)	63	64	64	64

INSTALLATION

Dimensions (WxHxD)	mm	(990x1808x750) + (1390x1808x750)*2	(1390x1808x750) + (1390x1808x750)*2	(1390x1808x750) + (1390x1808x750)*2	(1390x1808x750)*3	
Package dimensions (WxHxD)		(1090x1990x860) + (1490x1990x860)*2	(1490x1990x860) + (1490x1990x860)*2	(1490x1990x860) + (1490x1990x860)*2	(1490x1990x860)*3	
Net weight/Gross weight	kg	976/1027	1104/1158	1104/1158	1104/1158	
Refrigerant / GWP		R-410A	R-410A	R-410A	R410A	
Refrigerant charge	kg	30	30	30	30	
Compressor type		Scroll	Scroll	Scroll	Scroll	
Tubing	Liquid pipe diameter	inches	3/4"	3/4"	3/4"	3/4"
	Suction pipe diameter	inches	1"1/4	1"1/4	1"1/4	1"1/4
	Max. tube length	mètre	175	175	175	175
Max. height between indoor and outdoor units (ODU up/down)	m	50/40	50/40	50/40	50/40	
Max. height between indoor units	m	15	15	15	15	
Environment temperature range	Cooling	°C	-5°/43° Dry bulb			
	Heating	°C	-15°/21° Dry bulb			
Maximum indoor units connectable	quantity	64	64	64	64	



NEW

+ PRODUCTS

- COP can reach 6.02.
- Compact design.
- Quiet solution.
- Double coil heat exchanger.

FEATURES

TECHNOLOGY:



R410A FLUID



DC INVERTER



- Capacity range from 8 HP to 36 HP.
- Designed for all commercial uses.
- Inlet water temperature range: From 7 to 45°C.
- Stacked installation.
- Constant EER and COP: no influence from outdoor temperature.
- DC Inverter compressor.

WATER FLOWLOGIC TECHNICAL DATA

		Drop only	Drop only	Drop only	
Outdoor units		YWC220-H13	YWC280-H13	YWC335-H13	
Part number		7SP14H038	7SP14H039	7SP14H040	
POWERS					
Capacity range	HP	8	10	12	
Cooling capacity	kW	22.4	28	33.5	
Heating capacity	kW	25	31.5	37.5	
ELECTRICAL PARAMETERS					
Phase/Tension/Frequency		3P/380-400V/50-60Hz	3P/380-400V/50-60Hz	3P/380-400V/50-60Hz	
Cooling	Rated power input	kW	4.50	6.00	7.70
	Max. power input	kW	13.00	15.00	17.00
	Rated current	A	7.20	9.60	12.32
	Max.current	A	20.79	23.99	27.19
Heating	Rated power input	kW	4.15	5.80	7.80
	Max. power input	kW	13.00	15.00	17.00
	Rated current	A	6.64	9.28	12.47
	Max.current	A	20.79	23.99	27.19
EER /COP			4.98/6.02	4.67/5.43	4.35/4.81
PERFORMANCE					
Water flow (HS)	m ³ /h	4.8	6	7.2	
Sound pressure level (HS)	dB(A)	50	51	53	
Sound power level (HS)	dB(A)	61	62	64	
INSTALLATION					
External dimensions (WxDxH)	mm	775x545x995	775x545x995	775x545x995	
Shipping dimensions (WxDxH)	mm	875x655x1182	875x655x1182	875x655x1182	
Net/Shipping weight	kg	172/183	172/183	172/183	
Compressor type		Scroll DC Inverter	Scroll DC Inverter	Scroll DC Inverter	
Refrigerant / GWP		R410A	R410A	R410A	
Refrigerant charge	kg	2	2	2	
Refrigerant liquid pipe	mm	3/8"	3/8"	1/2"	
Refrigerant gas pipe	mm	3/4"	7/8"	1"	
Oil equalization pipe	mm	3/8"	3/8"	3/8"	
Total pipe length	m	300	300	300	
Max. pipe length (Equivalent/Actual)	m	150/120	150/120	150/120	
Max drop between I.U.&O.U	m	50/40	50/40	50/40	
WATER SIDE					
Inlet water connection pipe	mm	DN32	DN32	DN32	
Outlet water connection pipe	mm	DN32	DN32	DN32	
Pressure drop(inlet and outlet)	Kpa	35	50	70	
Connection type		inner grooved	inner grooved	inner grooved	
Max. system water pressure	Mpa	1.6	1.6	1.6	
Inlet water temperature range (Cooling & Heating)	°C	7°/45°	7°/45°	7°/45°	
CONNECTION RATIO					
Connectable indoor unit ratio	%	50-130	50-130	50-130	
Maximum number of indoor units	unit	13	16	19	

*All the specifications are tested under nominal condition (in cooling, indoor temp. is 27°C DB/19°C WB; outdoor temp 35°C DB/24WB; in heating, indoor temp. is 20°C DB, in heating, outdoor temp. is 7°C DB/6°CWB).



+ PRODUCTS

- Quiet.
- 3D and long distance air supply.
- Hidden screen.
- Two sides drain.



RCV02
(included)



RWW05
(optional)



RWW03
(optional)



RWW07
(optional)

FEATURES

TECHNOLOGY:



R410A FLUID



ELECTRONIC EXPANSION VALVE

- EEV inside: for an easier installation.
- High-quality DC fan motor: Reduce the indoor unit noise greatly.
- Fashion design.
- Infrared remote controller included.

HBV TECHNICAL DATA

Indoor units	Drop only				Drop only			
	AWSI-HBV007-N11	AWSI-HBV009-N11	AWSI-HBV012-N11	AWSI-HBV016-N11	AWSI-HBV018-N11	AWSI-HBV024-N11	AWSI-HBV030-N11	
Phase	Single phase	Single phase	Single phase	Single phase	Single phase	Single phase	Single phase	
Part number	7SP02H012	7SP02H013	7SP02H014	7SP02H017	7SP02H015	7SP02H016	7SP02H018	
RATED POWER								
Cooling	kBtu/h	7.5	9.5	12.3	15.3	19.1	24.2	30.7
	kW	2.2	2.8	3.6	4.5	5.6	7.1	9
Heating	kBtu/h	8.5	10.9	13.6	17.1	21.5	27.3	34.1
	kW	2.5	3.2	4	5	6.3	8	10
ELECTRICAL PARAMETERS								
Phase/Tension/Frequency	1P/220-230V/50Hz							
PERFORMANCE								
Airflow	m³/h	600	600	600	800/720/650	800	1000	1600/1500/1400
Noise level (LS/MS/HS)	dB(A)	29/31/35	29/31/36	29/33/37	39/36/34	35/39/40	36/40/44	49/44/41
INSTALLATION								
External dimensions (WxHxD)	mm	855x280x200	855x280x200	855x280x200	1115x336x243	1115x336x243	1115x336x243	1115x336x243
Shipping dimensions (WxHxD)	mm	954x355x279	954x355x279	954x355x279	1206x418x342	1206x418x342	1206x418x342	1206x418x342
Net weight/Gross weight	kg	10.9/12.6	10.9/12.6	10.9/12.6	13/16.5	13/16.5	13/16.5	13/16.5
Liquid pipe diameter	inches	1/4"	1/4"	1/4"	1/4"	1/4"	3/8"	3/8"
Suction pipe diameter	inches	3/8"	3/8"	1/2"	1/2"	1/2"	5/8"	5/8"

Dimensions : 007-009-012 models

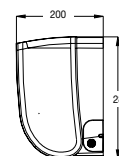
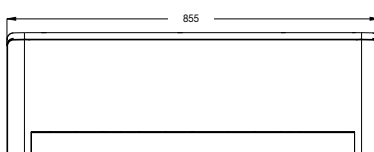

Dimensions : 018-024 models

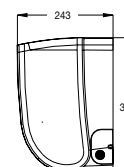
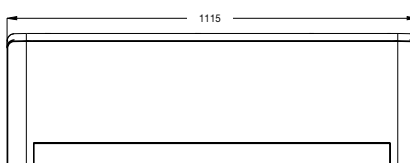

CBV

CASSETTE 600X600

Airwell
Just feel well



- Easy installation in false ceiling.
- Super quiet due to special fan design.
- Built-in high head pump (height up to 600 mm).
- Possible connection to a ventilation network due to a fresh air inlet (10-15% max).
- Dry contact: hotel/bungalow solutions (room card or on/off contact).

CBV TECHNICAL DATA

Indoor units		AWSI-CBV005-N11	AWSI-CBV007-N11	AWSI-CBV009-N11	AWSI-CBV012-N11	AWSI-CBV016-N11
Phase		Single phase	Single phase	Single phase	Single phase	Single phase
Part number		7SP04H020	7SP04H000	7SP04H001	7SP04H002	7SP04H003
RATED POWER						
Cooling	kBtu/h	5.1	7.5	9.5	12.3	15.3
	kW	1.5	2.2	2.8	3.6	4.5
Heating	kBtu/h	5.8	8.5	10.9	13.6	17.1
	kW	1.7	2.5	3.2	4	5
ELECTRICAL PARAMETERS						
Phase/Tension/Frequency		1P/220-230V/50Hz				
PERFORMANCE						
Airflow	m³/h	650	700	700	700	700
Noise level (LS/MS/HS)	dB(A)	28/29/31	29/30/32	29/30/32	29/30/32	29/30/33
INSTALLATION						
External dimensions (WxHxD)	mm	570x570x260	570x570x260	570x570x260	570x570x260	570x570x260
Shipping dimensions (WxHxD)	mm	718x680x380	718x680x380	718x680x380	718x680x380	718x680x380
Net weight/Gross weight	kg	17/21	17/21	19/21	19/21	19/21
Liquid pipe diameter	inches	1/4"	1/4"	1/4"	1/4"	1/4"
Suction pipe diameter	inches	3/8"	3/8"	3/8"	1/2"	1/2"
FRAME						
Frame part number		7ACVFH001	7ACVFH001	7ACVFH001	7ACVFH001	7ACVFH001
External dimensions (WxHxD)	mm	700x700x60	700x700x60	700x700x60	700x700x60	700x700x60
Shipping dimensions (WxHxD)	mm	740x750x115	740x750x115	740x750x115	740x750x115	740x750x115
Net weight/Gross weight	kg	2.8/4.5	2.8/4.5	2.8/4.8	2.8/4.8	2.8/4.8

Dimensions:

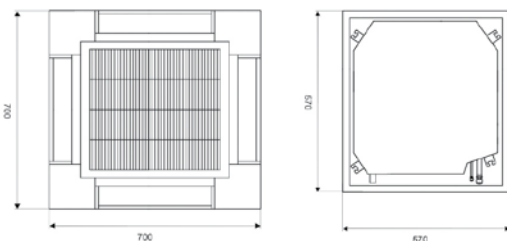

UPGRADE

+ PRODUCTS

- Quiet operation.
- Built-in high head drain pump.
- Fresh air inlet.
- Wired controller RWW05 included.
- EEV inside.
- Automatic swing.



RWW05 (included)



RCV02 (optional)



RWW03 (optional)



RWW07 (optional)

FEATURES

TECHNOLOGY:



R410A FLUID



ELECTRONIC EXPANSION VALVE



- Easy installation in false ceiling.
- Possible connection to a ventilation network due to a fresh air inlet (10-15% max).
- Built-in high head pump (height up to 600 mm).
- Better comfort due to its high air flow.
- Dry contact: hotel/bungalow solutions (room card or on/off contact).

+ PRODUCTS

- Compact design.
- Advance structure facilitating cleaning and installation.
- Fresh air inlet.
- EEV inside.
- Wired controller RWW05 included.
- Automatic swing.
- IR receipt included.



RWW05
(included)



RCV02
(optional)



RWW03
(optional)



RWW07
(optional)

FEATURES

TECHNOLOGY:



R410A FLUID



ELECTRONIC EXPANSION VALVE

CCV TECHNICAL DATA

Indoor units		AWSI-CCV018-N11	AWSI-CCV024-N11	AWSI-CCV030-N11	AWSI-CCV048-N11
Phase		Single phase	Single phase	Single phase	Single phase
Part number		7SP04H004	7SP04H005	7SP04H007	7SP04H009
RATED POWER					
Cooling	kBtu/h	19.1	24.2	30.7	47.7
	kW	5.6	7.1	9	14
Heating	kBtu/h	21.5	27.3	34.1	54.6
	kW	6.3	8	10	16
ELECTRICAL PARAMETERS					
Phase/Tension/Frequency		1P/220-230V/50Hz			
PERFORMANCE					
Airflow	m ³ /h	1200	1200	1800	1800
Noise level (LS/MS/HS)	dB(A)	30/32/34	31/35/34	31/35/37	35/39/42
INSTALLATION					
External dimensions (WxHxD)	mm	840x840x240	840x840x240	840x840x295	840x840x295
Shipping dimensions (WxHxD)	mm	930x930x330	930x930x330	930x930x390	930x930x390
Net weight/Gross weight	kg	30/36	30/36	38/40	38/40
Liquid pipe diameter	inches	1/4"	3/8"	3/8"	3/8"
Suction pipe diameter	inches	1/2"	5/8"	5/8"	5/8"
FRAME					
Frame part number		7ACVFH002	7ACVFH002	7ACVFH002	7ACVFH002
External dimensions (WxHxD)	mm	950x950x80	950x950x80	950x950x80	950x950x80
Shipping dimensions (WxHxD)	mm	985x985x115	985x985x115	985x985x115	985x985x115
Net weight/Gross weight	kg	6/9	6/9	6/9	6/9

Dimensions: 018-024-030-048 models

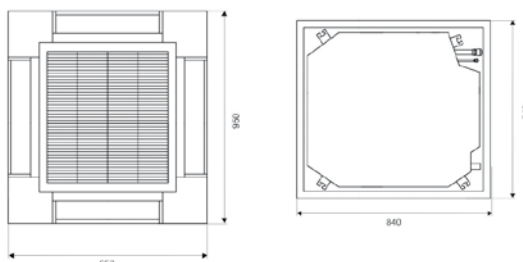



- Precise control of the air flow via wide angle louvers.
- Floor & ceiling installation.
- Long distance air throw.
- Dry contact: hotel/bungalow solutions (room card or on/off contact).



+ PRODUCTS

- Ultra-thin unit body, only thick 199 mm.
- Wide-angle airflow.
- Quiet running.
- EEV inside.
- Wired controller RWW05 included.
- Automatic swing.

FAV TECHNICAL DATA

Indoor units	Drop only				Drop only				
	AWSI-FAV009-N11	AWSI-FAV012-N11	AWSI-FAV018-N11	AWSI-FAV024-N11	AWSI-FAV028-N11	AWSI-FAV030-N11	AWSI-FAV038-N11	AWSI-FAV048-N11	
Phase	Single phase	Single phase	Single phase	Single phase	Single phase	Single phase	Single phase	Single phase	
Part number	7SP02H007	7SP02H008	7SP02H010	7SP02H011	7SP01H000	7SP01H001	7SP01H002	7SP01H003	
RATED POWER									
Cooling	kBtu/h	9.5	12.3	19.1	24.2	27.3	30.7	38.2	48
	kW	2.8	3.6	5.6	7.1	8	9	11.2	14
Heating	kBtu/h	10.9	13.6	21.5	27.3	30.7	34.1	42.6	55
	kW	3.2	4.0	6.3	8.0	9	10	12.5	16
ELECTRICAL PARAMETERS									
Phase/Tension/Frequency	1P/220-230V/50Hz								
PERFORMANCE									
Airflow (LS/MS/HS)	m³/h	580/710/800	580/710/800	580/710/800	580/710/800	1610/1820/2040	1610/1820/2040	1610/1820/2040	1610/1820/2040
Noise level (LS/MS/HS)	dB(A)	33/35/38	33/35/38	35/37/40	35/37/40	38/40/43	38/40/43	38/42/46	38/42/46
Sound pressure level (LS/MS/HS)		46/48/51	46/48/51	48/50/53	48/50/53	51/53/56	51/53/56	51/55/59	51/55/59
INSTALLATION									
External dimensions (WxHxD)	mm	990x655x199	990x665x199	990x655x199	990x665x199	1580x700x240	1580x700x240	1580x700x240	1580x700x240
Shipping dimensions (WxHxD)	mm	1160x730x280	1160x730x280	1160x730x280	1160x730x280	1720x800x330	1720x800x330	1720x800x330	1720x800x330
Net weight/Gross weight	kg	28.3/34.3	28.3/36.4	28.3/36.4	28.3/36.4	50/57	50/57	54/61	54/61
Liquid pipe diameter	inches	1/4"	1/4"	1/4"	3/8"	3/8"	3/8"	3/8"	3/8"
Suction pipe diameter	inches	3/8"	1/2"	1/2"	5/8"	5/8"	5/8"	5/8"	5/8"



RWW05 (included)



RCV02 (optional)



RWW03 (optional)



RWW07 (optional)

FEATURES

TECHNOLOGY:



R410A FLUID



ELECTRONIC EXPANSION VALVE

Dimensions: 012 to 024 models

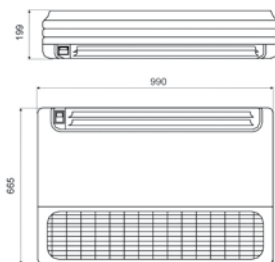

Dimensions: 28 to 48 models

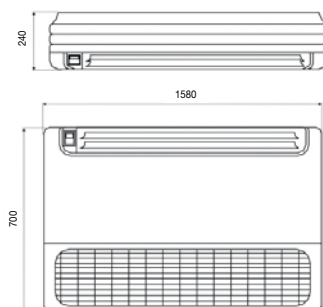



DAV 007-009-012



DAV 016

+ PRODUCTS

- 220 ultra thin design and space saving.
- Optional air return design.
- High efficiency filter G3.
- EEV inside.
- Wired controller RWV05 included on standard.
- Ideal for hotel



RWV05
(included)



RCV02
(optional)



(infrared receiver to combined with RCV 01)



RWV03
(optional)



RWV07
(optional)

FEATURES

TECHNOLOGY:



R410A FLUID



ELECTRONIC EXPANSION VALVE

- Invisible solution.
- Wide range: new size 7.
- Dry contact: hotel/bungalow solutions (room card or on/off contact).

DAV TECHNICAL DATA

Indoor unit		AWSI-DAV007-N11	AWSI-DAV009-N11	AWSI-DAV012-N11	AWSI-DAV016-N11
Phase		Single phase	Single phase	Single phase	Single phase
Part number		7SP03H001	7SP03H002	7SP03H003	7SP03H004
RATED POWER					
Cooling	kBtu/h	7.5	9.5	12.3	15.3
	kW	2.2	2.8	3.6	4.5
Heating	kBtu/h	8.5	10.9	13.6	17.1
	kW	2.5	3.2	4	5
ELECTRICAL PARAMETERS					
Phase/Tension/Frequency		1P/220-230V/50Hz			
PERFORMANCE					
Airflow	m³/h	400	400	500	850
Noise level (LS/MS/HS)	dB(A)	30/32/35	30/32/35	30/32/35	30/32/35
INSTALLATION					
External dimensions (WxHxD)	mm	610x220x500	610x220x500	610x220x500	1105x220x500
Shipping dimensions (WxHxD)	mm	710x280x549	710x280x549	710x280x549	1174x294x549
Net weight/Gross weight	kg	15/17	15/17	16/19	25/27
Liquid pipe diameter	inches	1/4"	1/4"	1/4"	1/4"
Suction pipe diameter	inches	3/8"	3/8"	3/8"	3/8"
Static pressure	Pa	20	20	20	20
ACCESSORY					
Water pump	Part Nb	7ACTL0529	7ACTL0529	7ACTL0529	7ACTL0529

Dimensions: 007-009-012 models

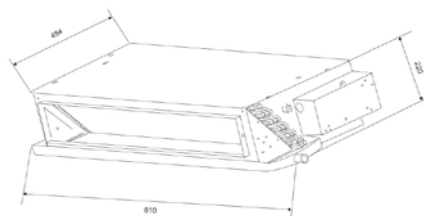

Dimensions: 016 model

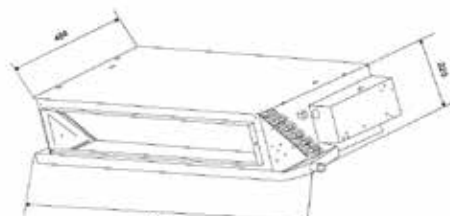

DBV DUCTED MEDIUM STATIC PRESSURE

Airwell
Just feel well



- Invisible solution.
- Two choices of static pressure: Better fitting with aeraulic network.
- Built-in high head pump (height up to 600 mm).
- Plenum for air outlet provided: 3 Ø200 sizes 018 and 028, 4 Ø200 size 038.
- Dry contact: hotel/bungalow solutions (room card or on/off contact).



DBV TECHNICAL DATA

Indoor units		AWSI-DBV018-N11	AWSI-DBV024-N11	AWSI-DBV028-N11	AWSI-DBV038-N11
Phase		Single phase	Single phase	Single phase	Single phase
Part number		7SP03H007	7SP03H008	7SP03H009	7SP03H011
RATED POWER					
Cooling	kBtu/h	19.1	24.2	27.3	38.2
	kW	5.6	7.1	8	11.2
Heating	kBtu/h	21.5	27.3	30.7	42.6
	kW	6.3	8	9	12.5
ELECTRICAL PARAMETERS					
Phase/Tension/Frequency		1P/220-230V/50Hz			
PERFORMANCE					
Airflow	m³/h	1200	1200	1200	1900
Noise level (LS/MS/HS)	dB(A)	35/37/43	35/37/43	35/37/43	35/37/43
INSTALLATION					
External dimensions (WxHxD)	mm	990x650x300	990x650x300	990x650x300	1410x645x350
Shipping dimensions (WxHxD)	mm	1167x860x345	1167x860x345	1167x860x345	1557x800x370
Net weight/Gross weight	kg	39/45	39/45	39/45	59/66
Liquid pipe diameter	inches	1/4"	3/8"	3/8"	3/8"
Suction pipe diameter	inches	1/2"	5/8"	5/8"	5/8"
Static pressure	Pa	50	50	50	50
Max. static pressure	Pa	96	96	96	96

Dimensions: 018-024-028 models

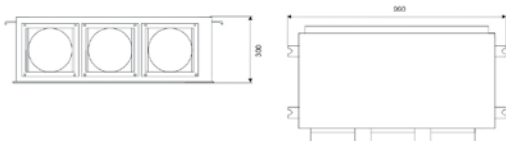

Dimensions: 038 model

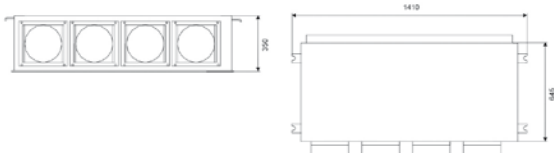

+ PRODUCTS

- Flexible static pressure selection, meeting the customers' personal requests.
- High efficiency filter G3.
- Special up-drainage water pump.
- EEV inside.
- Wired controller RWW05 included.



RWW05 (included)



RCV02 (optional)



(infrared receiver to combined with RCV 02)



RWW03 (optional)



RWW07 (optional)

FEATURES

TECHNOLOGY:



R410A FLUID



ELECTRONIC EXPANSION VALVE



DCV 048



DCV 072-096

+ PRODUCTS

- High efficiency filter.
- Free setting of air discharge duct.
- Multi install mode.
- High external static pressure design.



RWW05
(included)



RCV02
(optional)



RWW03
(optional)



RWW07
(optional)

- Invisible solution.
- Static pressure up to 196 Pa.
- Commercial application: high air flow and capacity up to 28 kW.
- Compatible with a textile duct application.



DCV TECHNICAL DATA

		Drop only						
Indoor unit		AWSI-DCV018-N11	AWSI-DCV024-N11	AWSI-DCV030-N11	AWSI-DCV038-N11	AWSI-DCV048-N11	AWSI-DCV072-N11	AWSI-DCV096-N11
Phase		Single phase	Single phase	Single phase	Single phase	Single phase	Single phase	Single phase
Part number		7SP03H014	7SP03H015	7SP03H016	7SP03H017	7SP03H018	7SP03H019	7SP03H020
RATED POWER								
Cooling	kBtu/h	19.1	24.2	30.7	38.2	47.7	77.1	95.5
	kW	5.6	7.1	9	11.2	14	22.6	28
Heating	kBtu/h	21.5	27.3	34.1	42.6	54.6	85.3	108.5
	kW	6.3	8	10	12.5	16	25	31.5
ELECTRICAL PARAMETERS								
Phase/Tension/Frequency		1P/220-230V/50Hz						
PERFORMANCE								
Airflow	m³/h	1089/1357/1500	1089/1357/1500	1133/1412/1560	1162/1448/1600	2100	4050	4050
Noise level (LS/HS)	dB(A)	38/40/42	38/40/42	40/43/45	40/43/45	40/45	49/54	49/54
INSTALLATION								
External dimensions (WxHxD)	mm	975x906x360	975x906x360	1355x876x360	1355x876x360	1197x360x830	1570x360x880	1570x360x880
Shipping dimensions (WxHxD)	mm	1048x943x413	1048x943x413	1378x938x405	1378x938x405	1430x420x940	1800x525x1000	1800x525x1000
Net weight/Gross weight	kg	48/58	48/58	62/77	62/77	62/77	100/111	100/111
Liquid pipe diameter	inches	1/4"	3/8"	3/8"	3/8"	3/8"	3/8"	3/8"
Suction pipe diameter	inches	1/2"	5/8"	5/8"	5/8"	5/8"	1"	1"
Static pressure	Pa	100/196	100/196	100/196	100/196	196	196	196

FEATURES

TECHNOLOGY:



R410A FLUID



ELECTRONIC EXPANSION VALVE

Dimensions: 018-024/030-038/048 models

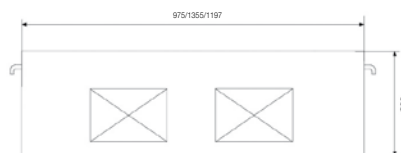

Dimensions: 072-096 models





- Esthetic and compact design.
- Ideal solution to replace electric heaters.
- Blowing up and down.
- Dry contact: hotel/bungalow solutions (room card or on/off contact).



+ PRODUCTS

- High efficiency filter.
- Quiet running.
- Compact unit body and space saving.
- EEV inside.
- Wireless controller included.



RCV02
(included)

FEATURES

TECHNOLOGY:



EAV TECHNICAL DATA		Drop only		Drop only	
Indoor unit		AWSI-EAV009-N11		AWSI-EAV012-N11	
Phase		Single phase	Single phase	Single phase	Single phase
Part number		7SP05H001	7SP05H002	7SP05H004	
RATED POWER					
Cooling	kBtu/h	9.5	12.3	17	
	kW	2.8	3.6	5.0	
Heating	kBtu/h	10.9	13.6	20.5	
	kW	3.2	4	6	
ELECTRICAL PARAMETERS					
Phase/Tension/Frequency		1P/220-230V/50Hz			
PERFORMANCE					
Airflow	m ³ /h	280/370/460	520	400/490/580	
Noise level (LS/MS/HS)	dB(A)	36/39/43	36/39/43	42/46/48	
INSTALLATION					
External dimensions (WxHxD)	mm	720x640x255	720x640x255	720x640x255	
Shipping dimensions (WxHxD)	mm	784x720x305	784x720x305	784x720x305	
Net weight/Gross weight	kg	18/20	18/20	18/20	
Liquid pipe diameter	inches	1/4"	1/4"	1/4"	
Suction pipe diameter	inches	1/2"	1/2"	1/2"	

Dimensions: 012 model

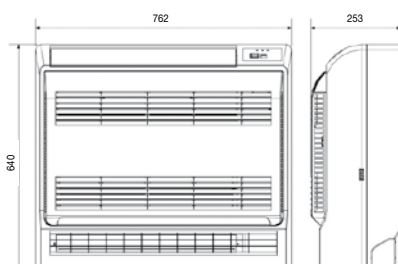

Dimensions: 009-018 models

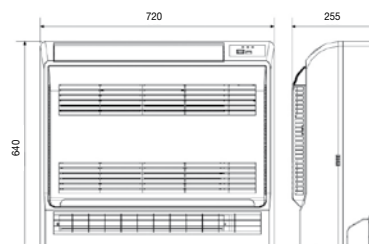

AHU Connection Kit

Airwell offers a range of connection kits to connect VRF outdoor units to third party DX air handling units.

SYSTEM APPLICATION

- Provides a solution for big space to cool down the supplied fresh air with VRF outdoor units to match the air handling units. Integrates all advantages of VRF and AHU units.
- EU legislation requires that every working place has to be supplied with a minimum of 25 m³/h/person of fresh air. So it means that every office, every shop and mostly every commercial building MUST have this solution in order to comply with the standard.



Buildings



Shopping centres



Hospitals

■ CONFIGURATION BETWEEN 28 AND 56 KW

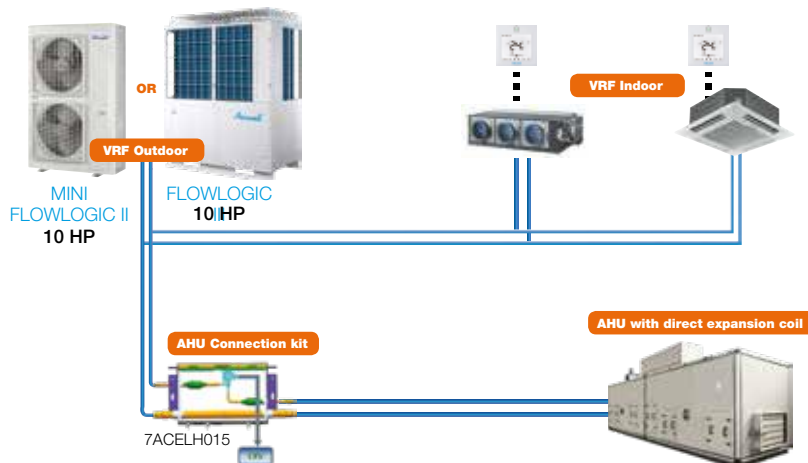

5 HP (14 kW) < Connected AHU capacity ≤ 10 HP (28 kW)

AHU and direct expansion coil to be purchased through other supplier

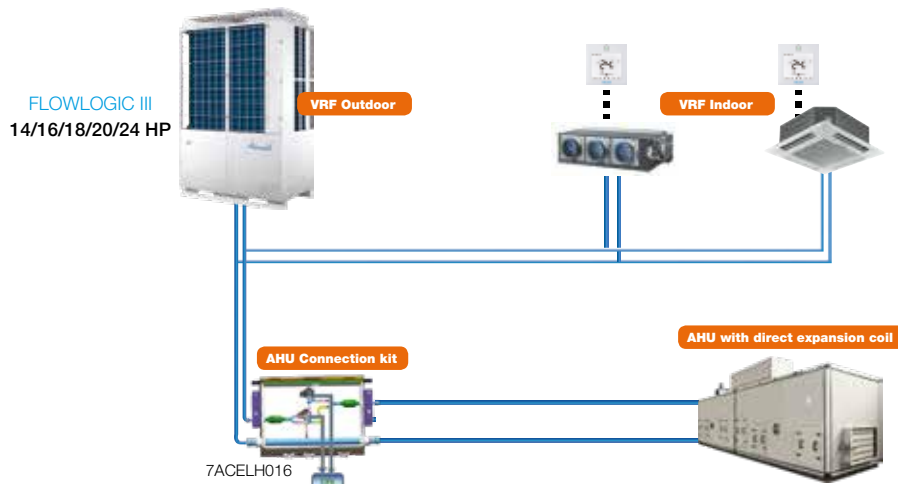

■ CONFIGURATION BETWEEN 14 AND 28 KW



10 HP (28 kW) < Connected AHU capacity ≤ 20 HP (56 kW)

AHU and direct expansion coil to be purchased through other supplier

VRF OUTDOOR LINE UP

OUTDOOR	MINI FLOWLOGIC II	FLOWLOGIC III
Modèle	All range	All range
		
Power supply	3P/380-400V/50Hz 3P/380-400V/60Hz	3P/380-400V/50Hz - 3P/380-400V/60Hz 3P/220V/60Hz - 3P/460V/60Hz
AHU kit	7ACELH015	
	5 HP (14 kW) < Connected AHU capacity ≤ 10 HP (28 kW)	10 HP (28 kW) < Connected AHU capacity ≤ 20 HP (56 kW)

AHU KIT CONFIGURATION

Airwell AHU Connection Kit consists in the following 4 parts:



Different Valve ▼ Same Control Parts

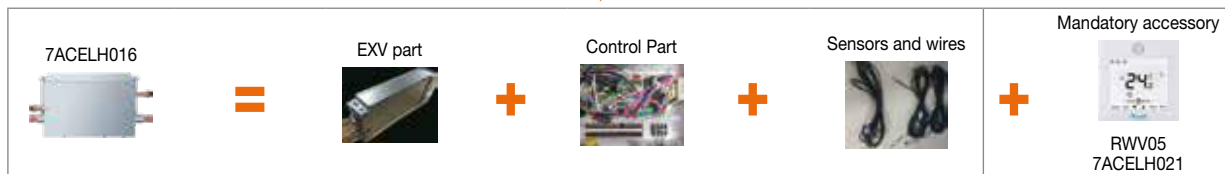

- EXV part, Control part, Sensor and wire are all integrated in one box.
- Controller need to be purchased separately.
- Temperature control via outlet air sensor on AHU.

WIRING DIAGRAM

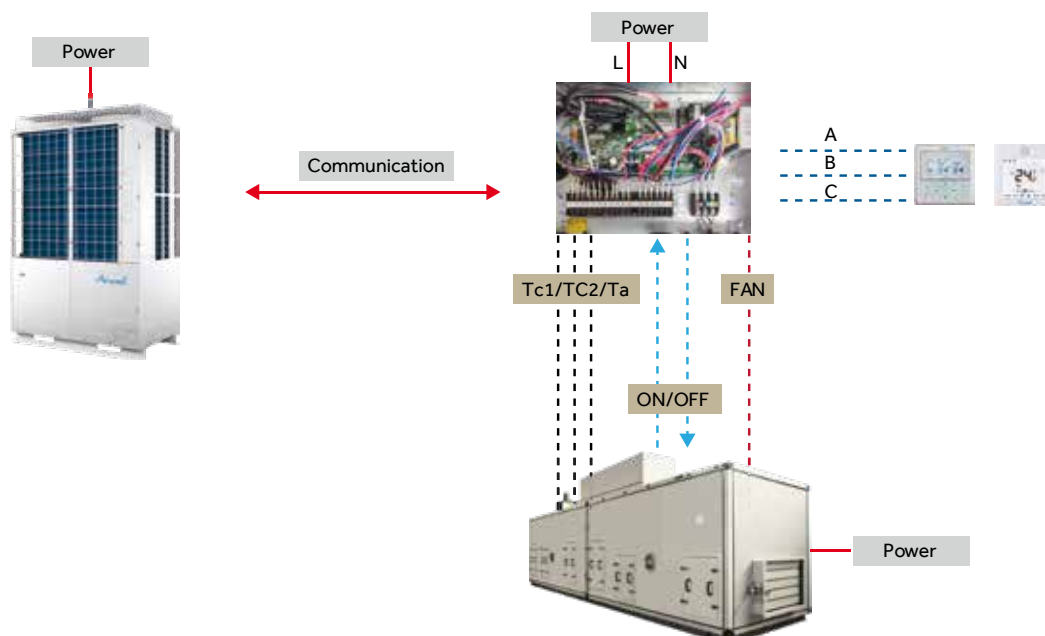

Solution de gestion centralisée avec ADV05

UNE SEULE PASSERELLE: SOLUTION CENTRALISÉE OU MODBUS

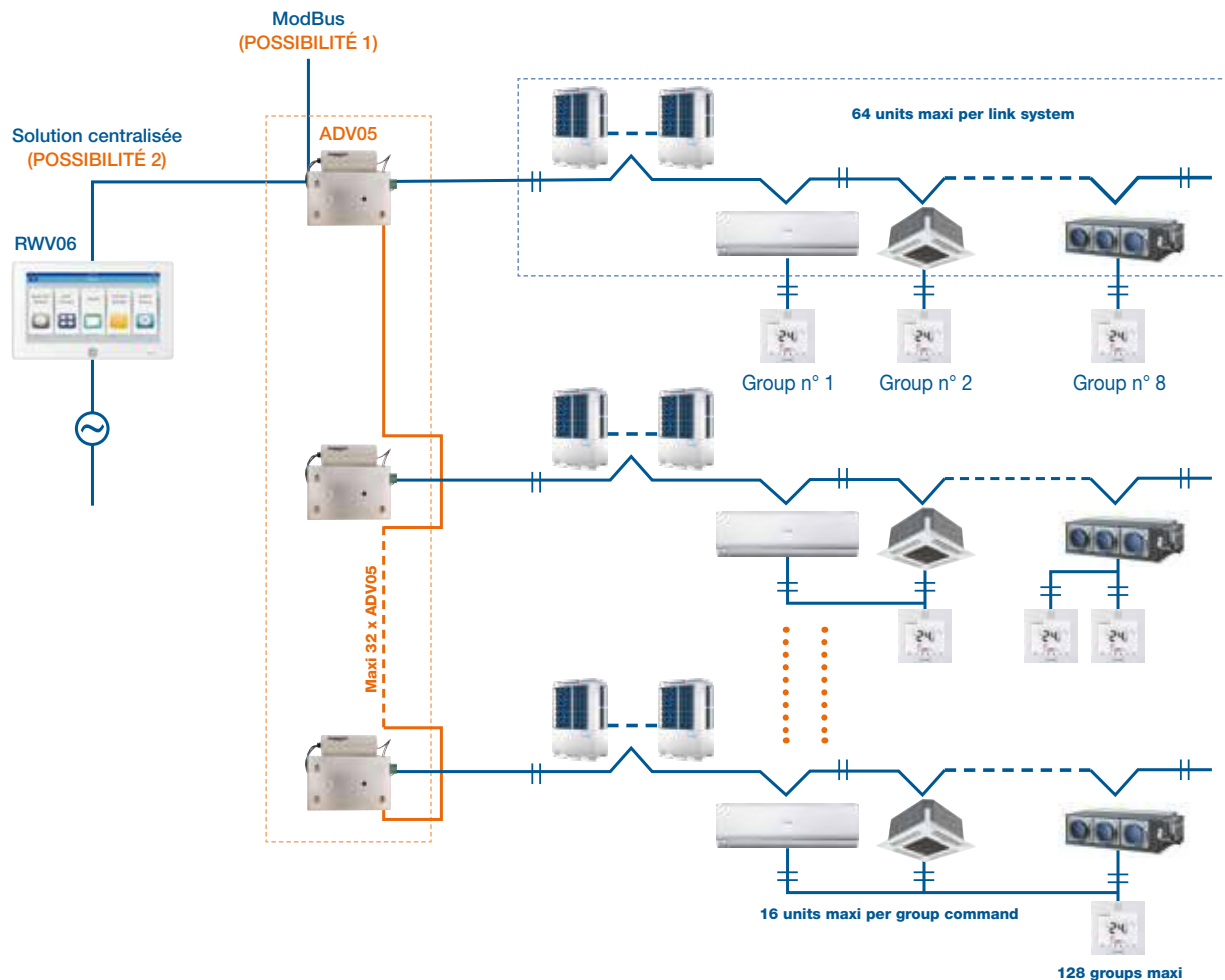

CENTRALE DE COMMANDE AVEC ÉCRAN TACTILE RWV06

Cette commande permet de contrôler et surveiller l'état des unités intérieures:

- Design sobre et moderne
- Utilisation intuitive et simple grâce à son écran tactile de 7 pouces
- Contrôle jusqu'à 256 unités intérieures et 128 groupes



Les principales fonctions sont:

- Lecture des paramètres de fonctionnement
- Visualisation des codes défauts et historique
- Programmation hebdomadaire: mode, vitesse de ventilation, température
- Priorité: verrouillage chaud froid LIFO (le premier entré est prioritaire)
- Création et pilotage de zones
- Sortie modbus RS485 -+







Part number RWV06: 7ACELH023







Lined writing area consisting of multiple horizontal dotted lines.

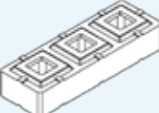



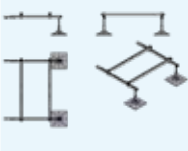



















ACCESSORY NAME	Photo	Part number	Model
CONTROLLERS		7ACELH022	RCV02
		7ACELH009	REC01
		7ACELH008	RWV03
		7ACELH021	RWV05
		7ACELH024	RWV07
		7ACELH025	RWV08
		7ACELH023	RWV06
BMS SOLUTIONS & MAINTENANCE		7ACELH007	ADV02
		7ACELH027	ADV05
		7ACELH014	TD02























































FUNCTION	FOR WHAT UNITS?	OPTIONAL/COMMENTS
ON/OFF, set temperature, auto scan, mode, individual control, timer.	All indoor units	Standard with high wall and console Optional with cassette and ducted
Realize infrared control	Ducted	-
Unit operating and group control (max. 16 indoor units)	All indoor unit types (except for console)	-
Unit operating, group control (max. 16 indoor units) and "I Feel" function.	High wall, ducted cassette, floor ceiling	Standard with cassette, ducted and floor ceiling
Single unit control, group control, max. 16 units, weekly timer, clock, mode cooling/heating/auto/airflow/dehumidification, temperature, fan speed, fan direction	High wall, cassette, ducted, floor ceiling	-
32 indoor units max., individual control, group control, central control, weekly timer, error display.	Mini FlowLogic II FlowLogic III FlowLogic II HR	ADV05 mandatory
Central control, single unit control, group control, max. 256 units, weekly timer, clock, mode cooling/heating/auto/airflow/dehumidification, temperature, fan speed, fan direction	Mini FlowLogic II FlowLogic III FlowLogic II HR	ADV05 mandatory
Protocol adapter and data storage	Mini FlowLogic II FlowLogic III FlowLogic II HR	Mandatory with energy counter
RWV06 and RWV08 connection and Modbus gateway	Mini FlowLogic II FlowLogic III FlowLogic II HR	-
Useful during process of installation or maintenance, the whole system's operating parameters can be tested.	Mini FlowLogic II FlowLogic III FlowLogic II HR	-

Installation accessories









NAME		Photo	Part number	FUNCTION	
COPPER	INSULATED COPPER M1		1/4"-3/8" - 10ml	7ACFH0810	Refrigerant tubing to connect outdoor unit with indoor unit (monosplit and multisplit).
			1/4"-1/2" - 10ml	7ACFH0811	
			3/8"-5/8" - 10ml	7ACFH0812	
			1/4"-3/8" - 7ml	7ACFH0813	
			1/4"-1/2" - 7ml	7ACFH0814	
			3/8"-5/8" - 7ml	7ACFH0815	
WALL BRACKET	Max. charge 160 kg Horiz. 560 mm Vert. 365 mm Barre 800 mm		7ACTL0506	Support to install an outdoor unit on facade (monosplit and multisplit).	
ANTI-CORROSION WALL BRACKET	Max. charge 160 kg Horiz. 460 mm Vert. 410 mm Barre 790 mm		7ACTL0507	Support to install an outdoor unit on facade (monosplit and multisplit).	
OUTDOOR UNIT SUPPORT	4 ANTI-VIBRATILE PADS (KIT)		7ACTL0508	Ideal to limit noise and vibrations (good neighborhood).	
	FLOOR SUPPORT RUBBER RECYCLED (PAIR)	Longueur 600 mm		7ACTL0509	Necessary for a professional installation. High quality: using rubber material.
		Longueur 1000 mm		7ACTL0510	
	FLOOR SUPPORT (PAIR)	450x100 mm		7ACTL0513	Necessary for a professional installation. Good quality price ratio: using PVC material.
RUBBER SUPPORT (PAIR+GLUE)	G600		7ACTL0511	Raise to avoid frosting. Compatible with floor support made of recycled rubber (same sizes).	
	G1000		7ACTL0512		

NAME		Photo	Part number	FUNCTION
FRAME VRF	FRAME VRF 4 FEET Max. charge 500 kg 1000x1200 mm		7ACTL0514	Available for all VRF outdoor unit range.
	FRAME VRF 6 FEET Max. charge 1040 kg 2000x1200 mm		7ACTL0515	Available for all VRF outdoor unit range.
	EXTENSION VRF 2 FEET Max. charge 500 kg 1000x1200 mm		7ACTL0516	Available for all VRF outdoor unit range.
CLEANING	FLUSH KIT FOR TUBING DIVERSIFLUSH		7ACFH0816	Cleans your old refrigerant circuit (to replace old R22 installation).
	SOLVENT CONTAINER DIVERSIFLUSH (REFILL)		7ACFH0817	
WATER PUMP	WATER PUMP MINI FLOWATCH MF2		7ACTL0517	Evacuate condensates from indoor units (high wall, ducted, floor ceiling units).
	WATER PUMP FLOWATCHDESIGN		7ACTL0518	Evacuate condensates from indoor units (high wall, ducted, floor ceiling units).

		WIRED REMOTE					WIRED REMOTE		
		RC08A	RC08C	RC08W	RC09	RC10	RCW2	RCW6	
RANGE		-	7ACEL1740	7ACEL1741	7ACEL1758	7ACEL1760	7ACEL1212	7ACEL1704	
									
HIGH WALL	HRD								
	HDM								
	HKD								
DUCTED	DLF								
	DLSE								
	DID								
CASSETTE	CCD								
FLOOR-CEILING	XBD								
	FCD								
	FWDB								
MONOBLOC	MAF								
	SDM								
LIGHT COMMERCIAL	HAN								
VRF	HBV								
	CBV								
	CCV								
	FAV								
	DAV								
	DBV								
	DCV								
	EAV								

	WIRED REMOTE								WIFI SOLUTION
	RCW8	RCW16	RWV05	RWV07	RWV03	RWV06	RWV08	BMS gateway	Airnet
	7ACEL1706 	7ACEL1707 	7ACELH021 	7ACELH024 	7ACELH008 	7ACELH023 	-	7ACEL1708 	- 
									 7ACEL1719
									 7ACEL1762 (sizes 7 to 12) 7ACEL1763 (sizes 18 and 24)
									 7ACEL1744
									
									
									
									
									
									
									
									
									
									
									
									

 Controller as standard  Optional controller

		INFRARED CONTROL			WIRED REMOTE				
		RC08C	RC08W	RC09	RCW2	RCW6	RCW8	RCW16	RCW10
		7ACEL1740	7ACEL1741	7ACEL1758	7ACEL1212	7ACEL1704	7ACEL1706	7ACEL1707	7ACEL1718
									
FUNCTION									
CUSTOMER	On/Off Timer	<input checked="" type="checkbox"/>	<input checked="" type="checkbox"/>	<input checked="" type="checkbox"/>	<input checked="" type="checkbox"/>	<input checked="" type="checkbox"/>	<input checked="" type="checkbox"/>	<input checked="" type="checkbox"/>	<input checked="" type="checkbox"/>
	Weekly Timer				<input checked="" type="checkbox"/>	<input checked="" type="checkbox"/>			
	Silent mode / low speed fan	<input checked="" type="checkbox"/>	<input checked="" type="checkbox"/>	<input checked="" type="checkbox"/>	<input checked="" type="checkbox"/>	<input checked="" type="checkbox"/>	<input checked="" type="checkbox"/>		<input checked="" type="checkbox"/>
	"I Feel" function	<input checked="" type="checkbox"/>	<input checked="" type="checkbox"/>	<input checked="" type="checkbox"/>					
	Clean-up function	<input checked="" type="checkbox"/>	<input checked="" type="checkbox"/>	<input checked="" type="checkbox"/>					
	Night mode (economy mode)	<input checked="" type="checkbox"/>	<input checked="" type="checkbox"/>	<input checked="" type="checkbox"/>	<input checked="" type="checkbox"/>		<input checked="" type="checkbox"/>		<input checked="" type="checkbox"/>
	Remote locking		<input checked="" type="checkbox"/>		<input checked="" type="checkbox"/>		<input checked="" type="checkbox"/>		<input checked="" type="checkbox"/>
	Turbo mode	<input checked="" type="checkbox"/>		<input checked="" type="checkbox"/>					<input checked="" type="checkbox"/>
	"Follow me" mode (presence sensor)			<input checked="" type="checkbox"/>		<input checked="" type="checkbox"/>			
	Low Battery	<input checked="" type="checkbox"/>	<input checked="" type="checkbox"/>	<input checked="" type="checkbox"/>	<input checked="" type="checkbox"/>	<input checked="" type="checkbox"/>	<input checked="" type="checkbox"/>	<input checked="" type="checkbox"/>	<input checked="" type="checkbox"/>
	No frost mode	<input checked="" type="checkbox"/>		<input checked="" type="checkbox"/>					
INSTALLER	Test mode	<input checked="" type="checkbox"/>		<input checked="" type="checkbox"/>					
	Group control				<input checked="" type="checkbox"/>	<input checked="" type="checkbox"/>		<input checked="" type="checkbox"/>	
	Centralized control	<input checked="" type="checkbox"/>	<input checked="" type="checkbox"/>	<input checked="" type="checkbox"/>	<input checked="" type="checkbox"/>				
	Temperature compensation	<input checked="" type="checkbox"/>		<input checked="" type="checkbox"/>					
	Heating mode only	<input checked="" type="checkbox"/>		<input checked="" type="checkbox"/>					
	Priority mode definition (multisplit)	<input checked="" type="checkbox"/>		<input checked="" type="checkbox"/>					
	Parameter display (temperature, off pressure opening, compressor...)	<input checked="" type="checkbox"/>		<input checked="" type="checkbox"/>					
	Defaults, failures display				<input checked="" type="checkbox"/>				

VRF

FUNCTION	INFRARED CONTROL	WIRED REMOTE					
	RCV02	RWV05	RWV07	RWV03	RWV06	RWV08	TD02
	7ACELH022 	7ACELH021 	7ACELH024 	7ACELH008 	7ACELH023 	7ACELH025 	7ACELH014 
On/Off Timer	●	●	●	●	●	●	
Weekly Timer			●		●	●	
Silent mode / low speed fan		●	●	●	●	●	
"I Feel" function						●	
CUSTOMER	Clean-up function		●	●	●	●	
	Night mode (economy mode)		●	●		●	
	Remote locking		●	●		●	
	Turbo mode			●			
"Follow me" mode (presence sensor)			●				
Low Battery	●	●	●	●	●	●	
INSTALLER	Supervision						●
	Group control		●	●	●	●	
	Centralized control	●				●	●
	Heating mode only		●	●			
	Defaults, failures display		●	●	●	●	●



Tool box

MEASURE UNITS CONVERSION

Length			
1 inch (in)	0.0254 m		
1 foot (ft)	12 inches	0.3048 m	
1 yard (yd)	3 feet	0.9143 m	
1 mile (mi)	1.760 yards	1609 m	
1 nautical mile (nmi)	1852 m		
1 meter (m)	39.37 inches	3.28084 feet	1.09361 yard

mm	Inches
6.35	1/4
9.52	3/8
12.70	1/2
15.88	5/8
19.05	3/4
22.22	7/8
25.40	1
28.58	1"1/8
31.75	1"1/4
38.10	1"1/2

Volume	
1 cubic inch (cu in)	16.387064 cm ³
1 cubic foot (cu ft)	0.028317 m ³ /28.31685 dm ³
1 cubic yard (cu yd)	0.76455 m ³
1 pint	0.568 l
1 gallon-imp	4.546 l
1 gallon (US gal)	3.78541 l or dm ³
1 cubic meter (m ³)	35.31467 cu ft
1 cubic decimeter (dm ³)	0.26428 gal
1 liter (l)	1 dm ³

HP (horse power) *	Btu	kW
1	9000	2.637
1.5	12000	3.516
2	18000	5.274
2.5	24000	7.032
3	30000	8.79
5	45000	13.185

Mass volume	
1 cu.ft/lb	62.43 dm ³ /kg
1 US gallon/pound	8.3 dm ³ /kg

Density	
1 pound/cu.ft	0.016 kg/dm ³

Mass		
1 ounce (oz)	28.349 g	
1 pound (lb)	16 oz	0.4536 kg
1 quintal U.S	100 lbs	
1 centweight	112 lbs	
1 short ton (US)	2000 lbs	907.18 kg
1 long ton (GB)	2240 lbs	1016.04 kg
1 quintal (q)	100 kg	
1 tonne (t)	1000 kg	

Area		
1 square inch (in ²)	6.4516 cm ²	
1 square foot (ft ²)	0.0929 m ²	
1 square yard (yd ²)	0.8361 m ²	
1 square meter (m ²)	1550 in ²	10.76391 ft ²

Energy - Heat quantity		
1 cal	4.18 joules	
1 Btu	0.252 kcal	1055 joules
1 Btu/lb.°F	1 kcal/kg °C	
1 kcal	1 millithermie	
1 fg/h	-1 kcal/h	
1 kcal/h	1.163 W	
1 Btu/h	0.293 W	
1 ton (US)	3024 kcal/h	3512 W
1 ton (GB)	3340 kcal/h	3878 W
1 watt (thermic)	0.86 kcal/h	

° Fahrenheit = °C x 9/5 + 32
 ° Celsius = (°F-32) x 5/9
 ° Celsius = T (Kelvin) - 273.15
 * Indicative values

Rated power of our products are given for air conditions as following:
 Cooling mode: 35°C out/27°C in (Dry bulb)
 Heating mode: +7°C out/20°C in (Dry bulb)

SIZING THE AIR CONDITIONING

STEP 1: EVALUATING THE NEEDS

In order to size properly your air conditioning installation, it's important to calculate the thermal needs of your habitation to calculate the power needed for your setup.

■ SIZING THE COOLING NEEDS BY OCCUPANCY RATIO

We use the following ratio to calculate the cooling power needed:

$$90 \text{ W/m}^2 + 100 \text{ W/Occupant}$$

The calculation is to be done room by room.

■ SIZING THE HEATING NEEDS BY THE G METHOD

The « G » is the volume loss coefficient of the building, matching the sum of the thermal loss through walls, windows, roofs... It's expressed in $\text{W/m}^3/\text{°C}$. This coefficient is related to the building isolation.

$$\text{Heat power (W)} = G \times V \times \Delta T$$

G = global loss coefficient ($\text{W/m}^3 \times \text{°C}$):

- 0,65 W/°C m^3 new construction
- 0,75 W/°C m^3 construction after 2000
- 0,9 W/°C m^3 constructions after 1980
- 1,2 W/°C m^3 constructions moderately insulated
- 1,8 W/°C m^3 constructions poorly insulated

V = building volume (m^3)

ΔT = Temperature difference between interior (19 or 20°C), and average exterior temperature in the region where is based the project.

STEP 2: EXTERIOR UNITS SELECTION

Dispatch the cooling and heating needs calculated before (cf. step 1).

Calculate the global needs by zone, in order to determine outdoor unit capacity.

STEP 2: EXTERIOR UNIT SELECTION				
Zone	Rooms	Cooling needed (kW)	Heating needed (kW)	Maximum number of interior units desired
Zone 1	Room n°1			
	Room n°2			
	Room n°3			
	Room n°4			
	Room n°5			
	Room n°6			
	TOTAL			
Zone 2	Room n°1			
	Room n°2			
	Room n°3			
	Room n°4			
	Room n°5			
	Room n°6			
	TOTAL			
Zone 3	Room n°1			
	Room n°2			
	Room n°3			
	Room n°4			
	Room n°5			
	Room n°6			
	TOTAL			

TECHNOLOGY



FLEXY MATCH

Indoor units are compatible with mono or multisplit installation.



DC INVERTER

Compressor with high efficiency DC engine.



R410A FLUID

Refrigerant fluid R410A.



R407C FLUID

Refrigerant fluid R407C.



R32 FLUID

Refrigerant fluid R32.



ELECTRONIC EXPANSION VALVE

Precise control of coolant flow, optimization of performance and compressor protection.



4D AIRFLOW

Heating and cooling operations are optimized with an automatic horizontal and vertical oscillation.



MULTIFLOW 360°

Air distribution system with great comfort on 360° and 4 directions with motorized opening control.



TWIN APPLICATION

An outdoor unit is connected to two similar indoor units.



CRANKCASE HEATER

Protects compressor oil from freezing.

AIR QUALITY/CLEAN



STERIONIZER

Generates sterionizer ions producing electrochemical reaction destroying bacteria, viruses and allergenic particles. Creates and ensure provisioning of natural and high quality air in living environment.



NANO PHOTOCATALYTIC FILTER

Oxidizes and degrades organic contaminants. It can eliminate up to 99.9% of bacteria and can efficiently block dusts.



AIR FILTER

Eliminates fine particles and purifies the air.



AUTO CLEAN/DRY

Prevents development of bacteria and moistures keeping the heat exchanger dry after a cooling operation.



FRESH AIR

Cools the room bringing fresh air from outside.



FILTER CLEAN INDICATION

Control led asking for verification and cleaning of the air filter.

USER FUNCTIONS



I FEEL

Precise control of temperature all around the chosen zone via a remote temperature sensor.



SLEEP MODE

Temperature in the room adjustment based on sleeping habits.



QUIET MODE

Top design for the lowest sound level.



REFRIGERANT LEAKAGE DETECT

Indicates a refrigerant leakage on indoor unit and stops the system for compressor protection.



PROGRAMMABLE TIMER

Adjustable timer for power on and power off.



AUTO RESTART (MEMORY)

Restarts automatically the unit in the last used mode when power is back.



REMOTE CONTROL LOCK

Locks the remote functions to avoid unexpected actions.



WIFI

Air conditioner controlled via mobile phone, tablet or computer through a wireless router and internet, thanks to AIR NET application.



REDUNDANCY FUNCTION

Product compatible with Airwell redundancy solution.

INSTALLER FUNCTIONS



DIGITAL DISPLAY

Digital display of error codes or temperature settings on the indoor unit.



SELF DIAGNOSTIC

Unit failure indication through a blinking led on the unit display.



INTEGRATED WATER PUMP

Eliminates condensate for a simple and smooth use.



LEFT/RIGHT DRAIN CONNECTION

Easy installation connecting condensate tubing either on left or right side.



ALARM OUTPUT

Remote transmission of dysfunction errors.



UNIT ON OUTPUT

Displays on the remote the power on or power off status of the unit.



DRY CONTACT ON/OFF

Connection to an external presence detection with adjusted control of the unit and power saving when the room is empty.



BMS COMPATIBLE

Connection to the BMS system via PCB adapter.



SERVICE MONITOR TOOL

PC interface for monitoring and adjusting the settings of the unit.



POWER CONSUMPTION CONTROL

Energy consumption control reducing the maximum power on the unit.



OUTDOOR UNIT NIGHT MODE DRY CONTACT

Engine speed limitation and noise level reduction of the outdoor unit.



OUTDOOR UNIT STAND-BY

Power on or power off of the outdoor unit from the remote.



OUTDOOR UNIT ALARM OUTPUT

Transmission of an air output default alarm to a remote system.



TECHNICIAN TEST MODE

Special mode optimizing the duration of intervention of the technician.



A series of horizontal dotted lines spanning the width of the page, providing a guide for handwriting practice.

Airwell

AIR CONDITIONING & HEATING

Our Aftersales Service

Export

Tel ■ +33 (0)1 76 21 82 95

SPARE PARTS ORDERS:

e-mail ■ sales@adhoc-pro.com

TECHNICAL SUPPORT:

e-mail ■ technical-spfr@airwell-res.com

Airwell
Residential

3, AVENUE DU CENTRE, LES QUADRANTS, BÂT. A - 78280 GUYANCOURT, FRANCE
TEL.: +33 (0)1 76 21 82 00 - FAX: +33 (0)1 76 21 82 01 - www.airwell-res.com